

D A R R A N

# Reception Park

price list | effective January 2016 | updated 1.20.17



## RECEPTION PARK PRICE LIST REVISIONS

<b>DATE</b>	<b>PAGE</b>	<b>MODIFICATION</b>	<b>DESCRIPTION</b>
7.20.16	ALL	Removed Finish	Removed discontinued finish GRC Caramel Cherry

**TABLE OF CONTENTS**

Product index ..... 2  
 General Information ..... 3  
 Limited Lifetime Warranty ..... 4  
 Damages | Returns | Repairs ..... 5  
 Ordering Information ..... 6  
 GSA Customer Information ..... 7  
 Freight..... 8  
 Features & Advantages ..... 9  
 Finishes | Specifications..... 11  
 Edges | Pulls ..... 12  
 Grommets | Grommet Reference ..... 13  
 Ganging | Height Reference ..... 14  
 Modesty Reference | Grain Direction..... 15  
 Drawer Dimensions | Filing Reference ..... 16  
 Desk Shells ..... 17  
 Corner Shells..... 18  
 Reception Workstation Returns ..... 19  
 Bridges ..... 21  
 Reception Workstation Credenzas ..... 22  
 Pedestals ..... 25  
 Counters..... 26  
 Options ..... 32  
 Power and Data..... 55

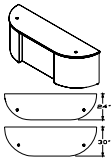

PAGE 17  
DESK SHELL

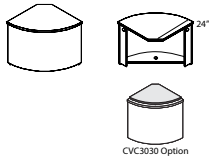

PAGE 18  
CORNER SHELLS

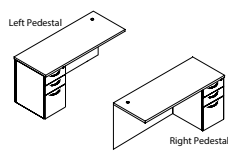

PAGE 19  
RECEPTION WORKSTATION  
RETURNS 24" D

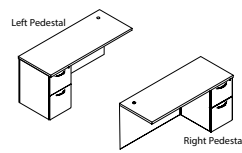

PAGE 20  
RECEPTION WORKSTATION  
RETURNS 24" D

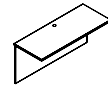

PAGE 21  
RECEPTION "U" WORKSTATION  
BRIDGES

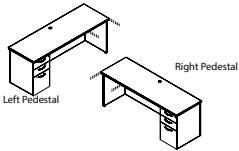

PAGE 22  
RECEPTION WORKSTATION  
CREDENZA

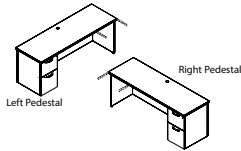

PAGE 23  
RECEPTION WORKSTATION  
CREDENZA

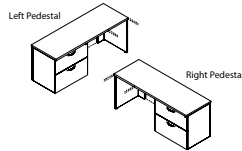

PAGE 24  
RECEPTION WORKSTATION  
CREDENZA

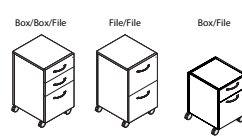

PAGE 25  
PEDESTALS

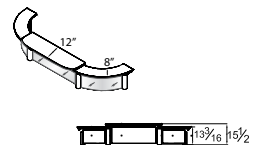

PAGE 26  
COUNTERS

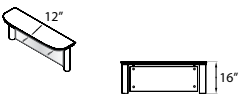

PAGE 27  
COUNTERS



PAGE 28  
COUNTERS



PAGE 29  
COUNTERS



PAGE 30  
COUNTERS

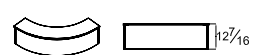

PAGE 31  
COUNTERS



All DARRAN products are proudly manufactured in the U.S.A.

**BUILT TO ORDER**

Manufactured per order the way you want it, including modifications.

**FULLY ASSEMBLED**

Unless otherwise noted, all products are fully assembled and ready to use, including add-on options.

**PERFORMANCE TESTED**

All products are tested to ensure performance exceeds BIFMA / ANSI standards.



**GREEN CERTIFIED**

DARRAN has been committed to improving indoor air quality of office buildings since 1996. Since then, finish technology has allowed our commitment to continue with products that are air quality Certified Green.

DARRAN is proud to announce that all in veneer, laminate, and guest seating are MAS Certified Green for complying with the ANSI/BIFMA X 7.1 standard / LEED 4.5 Standard for low –VOC emitting Furniture.

MAS is an independent emission testing laboratory that is ISO 17025 compliant using ASTM, ANSI and CEN methods. MAS is a true 3rd party certification through NSF International to BIFMA standards and California’s ARB formaldehyde standard. Certification of compliance under the Low – VOC emitting Furniture testing, qualifies products for LEED 4.5 credits.



**FINISH TECHNOLOGY**

DARRAN has continued its partnership with AkzoNobel Chemicals ([www.akzonobel.com](http://www.akzonobel.com)) to develop a new finish technology further improving indoor air quality with a coating that meets today’s environmental standards and supports LEED buildings.

ENVI-CT (Environmental Coatings Technology) utilizes advanced European finish technology to deliver a high-end furniture coating with superior performance in appearance and durability, allowing DARRAN to deliver more sustainable products to our customers.

*ENVI-CT Advantages:*

- › ENVI-CT is a re-engineered high performance Coatings Top Coat
- › Exceptional hardness and clarity
- › Highly resistant to solvents and chemicals
- › Plasticizer Migration resistant
- › Excellent UV inhibitors for maximum color resistance
- › Exceeds current and proposed future Federal and State air quality requirements
- › Field Repairable
- › Dynamic chamber emissions tested and certified compliant to ANSI/BIFMA X 7.1 Standard / LEED 4.5 Standard for low – VOC emitting furniture.
- › Standard with Anti-microbial additive.

**ADVANTAGES**

DARRAN has upgraded the standard Anti-microbial protection, to , the latest in Silver Ion Technology. DARRAN collaborated with the world’s leader in finishing materials, to formulate an additive that will inhibit the growth of mold, mildew, fungus and bacteria on wood surfaces. This additive infuses Silver Ions into DARRAN’s ENVI-CT (Environmental Coatings Finish Technology), creating a protective surface for the life of the furniture. The best part - is standard on all DARRAN Caseloads for no additional fee.



## LIMITED LIFETIME WARRANTY

DARRAN Furniture Industries, Inc. ("DARRAN") warrants that each piece of furniture manufactured in its North Carolina Facilities will be free from defects in material and workmanship for as long as the original purchaser owns and uses the product. Subject to the limitations and exclusions herein, DARRAN, at its discretion and as the sole remedy under the DARRAN Limited Lifetime Warranty, will replace or repair a defective product or components with comparable product or components free of charge. This warranty is made only to the original purchaser from an authorized DARRAN dealer, for as long as that original purchaser owns and uses the product.

### LIMITATIONS: USE / CARE

- › Warranty is limited to normal single shift use.
- › Warranty is limited to generally accepted care and maintenance of natural wood products and environments.
- › Natural wood surfaces are subject to denting, scratching, and gauging if not properly used and cared for. Warranty is subject to use and care in accordance with the use and care instructions provided in the Product Care section of this site (including, but not limited to, the care and maintenance guide downloads linked thereon), available at [www.darran.com/product-care](http://www.darran.com/product-care), which are incorporated herein by reference.

### LIMITATIONS: MATERIALS / COMPONENTS

- › Laminates, Veneers / Finishes - 10 Years
- › Electrical lamps, Ballasts, Transformers - 5 Years
- › Fabrics, Pneumatic lifts, Foam - 5 Years
- › Custom products built to customers specifications - 3 Years

### WARRANTY EXCLUSIONS

*Damage identified as carrier or installer related.*

- › Normal wear and tear of wood products during course of ownership.
- › Color, grain, or texture of natural wood materials, laminates, and other covering materials.
- › Damages or failures resulting from misuse, abuse, negligence, improper care, modifications, or relocation.
- › Non Commercial use or locations.
- › So-called "ghost" indentions and similar damage caused by the failure to use appropriate desk or writing pads.

All Warranty Claims are subject to DARRAN-approved inspections. Disputes may involve independent third-party evaluation

### QUALITY ASSURANCE

DARRAN manufactures in accordance with the standards set by Architectural Woodwork Institute (AWI) for Quality Standards.

Every unit produced at DARRAN is completely inspected by an independent quality control team located within each plant whose emphasis is on assembly, finish, and final inspections with empowerment to stop any unit not meeting DARRAN's high quality standards.

### LIGHT AND NATURAL FINISHES

The beauty of veneer and all wood products comes from the variations created by nature including color, grain, and texture.

These variations are not considered defects and DARRAN's Limited Lifetime Warranty does not cover color, grain and texture variations associated with natural wood and grain seen in any finish color. DARRAN sets standards for veneer selections; however, variations, especially apparent in light/natural finishes, will occur from one piece to another even if they are finished at the same time.

Finishes such as Clear Maple, Light/Gunstock Walnut, and Clear/Caramel Cherry will display more natural characteristics due to their light stain. Grain, pattern and color from unit to unit are not guaranteed or warranted and products will not be replaced due to these variations. Exposure to light and age will cause darkening of natural wood products; therefore DARRAN cannot guarantee or warrant finish match of new products being placed with existing products in the field.

### GLASS

Use of glass overlays on surfaces will void DARRAN's Limited Lifetime Warranty, unless the overlay is installed and maintained in strict accordance with DARRAN's instructions. If an overlay is to be used, please contact DARRAN for installation and maintenance instructions.

### GENERAL

Performance questions will be tested to generally accepted practices and AWI guidelines and standards for wood veneer furniture. To obtain performance of the Limited Lifetime Warranty, the purchaser should contact in writing the authorized DARRAN representatives or current dealer who sold the product to the purchaser or mail the warranty claim to:

Warranty Department  
DARRAN Furniture Industries, Inc.  
P.O. Box 7614  
High Point, NC 27264  
Telephone: 336-861-2400      Toll Free: 800-334-7891  
email: [warranty@darran.com](mailto:warranty@darran.com)

EXCEPT FOR THE LIMITED LIFETIME WARRANTY EXPRESSLY DESCRIBED HEREIN, DARRAN MAKES NO OTHER REPRESENTATION OR WARRANTY OF ANY KIND, EXPRESS OR IMPLIED. DARRAN MAKES NO WARRANTY OF MERCHANTABILITY OR FITNESS FOR A PARTICULAR PURPOSE, AND DARRAN WILL NOT UNDER ANY CIRCUMSTANCES BE LIABLE FOR ANY INCIDENTAL OR CONSEQUENTIAL DAMAGES, OR ANY INDIRECT OR SPECIAL DAMAGES.

### THE WARRANTY AS STATED ABOVE, SUPERSEDES ALL PREVIOUS WARRANTIES

**NO HASSLE FREIGHT DAMAGED MERCHANDISE**

DARRAN products are packed in specially designed cartons and padding that protects all edges and corners from damage. This is proven by an industry low damage rate of .0030% per total pieces shipped.

For qualified freight damage claims DARRAN will take responsibility for the claim and remedy processes including assuming total cost coverage from claim settlements.

(Some items may not qualify. Contact Factory for specific details.)

**QUALIFIED CLAIM CONDITIONS****VISIBLE CARTON DAMAGE**

1. Take digital pictures of the damaged carton and damaged furniture if visible damage is found upon delivery at the dock
2. Open all cartons with puncture or crushed corner damage.
3. Note any damage to the goods on the Carrier's freight bill as number of pieces damaged.

**CONCEALED DAMAGE**

1. Take digital pictures of the furniture as it sits partially unpacked. Also, photograph external and internal carton materials that correspond with the damaged area on the product.
2. Carton and damaged unit(s) must be located at the location matching the original delivery address for Carrier inspection.
3. Digital pictures must be provided of the damaged furniture and carton materials

For qualified claims per above contact DARRAN Customer Service Department at 1-800-334-7891 or complete DARRAN's online warranty report form within the 15 day limit. [www.darran.com/warrantyreport](http://www.darran.com/warrantyreport)

**NON-QUALIFIED CLAIM CONDITIONS**

1. Deliveries made to non-dock locations
2. Claims made after furniture is installed and/or removed from original delivery location
3. Carton and padding has been discarded
4. Carrier used was not DARRAN approved
5. Inspection reveals questionable damages

**REPLACEMENT ORDERS**

Replacement orders entered without replacement tagging or factory authorization is considered a new order without dispute, therefore full payment is expected and will be collected.

**RETURN SHIPMENTS**

DARRAN will not accept return of merchandise without a signed RA (return authorization) form.

DARRAN will specify the carrier to be used. Return bills of lading must be marked "Class 125" freight rate and a copy of the RA should be used as a packing list. All returns must be received by DARRAN within 30 days of the RA date or the products will be considered accepted by the customer.

All products being returned must be properly packed and protected to avoid freight damage. Whenever possible, use the original cartons in which the merchandise was shipped. Freight

damage, signs of usage, missing parts, etc., will result in an adjustment of any credit to be issued.

DARRAN will issue RA's for the following reasons:

1. Manufacturing defect (inspection required)
2. Order processing error by DARRAN
3. Shipping error
4. Mismatched carton / merchandise

**SPECIFICATION CHANGES**

We reserve the right to change without notice any dimension, style, or specification of any model in the DARRAN line. Dimensions shown in the price list are nominal. It is the buyer's responsibility to read specification carefully when matching existing goods is desired.

**MANUFACTURING DEFECTS**

Claims of manufacturing defects will not be entertained without prior consultation with DARRAN's warranty department. Unauthorized deduction in payment of invoices will not be allowed without prior factory approval. Unapproved deductions are subject to factor's late payment charges.

**DAMAGE CLAIMS**

Claims of manufacturing damage or freight damage reported as nicks, dents, scratches, etc. after installation of furniture will not be covered under warranty or freight claim.

**ATTENTION:** Damage claims involving glass or stone components must be inspected and damage noted on delivering freight bill to qualify for replacement.

**REPAIR CHARGES**

Factory authorization must be secured from DARRAN's warranty department prior to incurring repair charges. Warranty will utilize DARRAN's National Repair Service through the Furniture Medic Franchise ([www.furnituremedic.com](http://www.furnituremedic.com)).

Repair charge authorizations are based on:

- › Set travel rate
- › Average regional job rate
- › Factory set maximum repair time
- › Falsely reported defect claims are subject to local service charges being charged to dealer/distributor.

**FINISH MAINTENANCE**

Wood office furniture and wood finishes can retain their natural beauty for life if proper care is taken and a stable environment is provided. Fluctuations in humidity and temperature cause panels and solid wood components to expand and contract and may lead to panel warpage and finish "checking" or cracking. Prolonged exposure of furniture to dry heat during winter months should be avoided. Careful examination of interior wood trim may indicate a damaging dry environment. If open joints, splits and cracks are appearing in trimwork consult with a HVAC professional for appropriate remedy.

DARRAN finishes are field repairable should damage occur. Professional furniture repair services are recommended. Regular cleaning with a non-silicone polish is recommended.



**ORDERING**

All orders should be emailed, mailed or transmitted by fax to:

DARRAN Furniture Industries, Inc.  
P.O. Box 7614  
High Point, NC 27264  
email: orders@darran.com  
Fax: 336-861-6485

DARRAN will only accept orders from authorized Dealers. All orders must be accurate and detailed. All Quick Ship orders must contain Quick Ship product ONLY. Orders should be separated and submitted according to lead time. Orders must contain Quick Ship code "QS" or have designated Quick Ship lead time to ensure correct order entry. Orders that contain multiple lead time products will be entered as one order and scheduled with the most extended lead time.

**CREDIT APPROVAL**

All orders are subject to credit approval for open account. All new accounts must be approved by a local DARRAN Sales Representative and should submit current financial information and trade references to:

DARRAN Furniture Industries, Inc. ATTN: Credit Department  
P.O. Box 7614  
High Point, NC 27264  
Telephone: 336-861-2400 Toll Free: 800-334-7891  
Fax: 336-861-2512

Orders submitted without accounts pre-approval or credit approval are subject to acceptance with lead times scheduled only after approval dates.

**LEAD TIME SCHEDULE**

DARRAN cannot assign a firm lead time until Credit approval and order accuracy are complete. Extended lead times due to credit or information delays are the responsibility of the Buyer.

**ORDER DELAY / HOLD**

Due to the committed manufacturing cost on Quick Ship processes, DARRAN cannot delay or hold orders, either in process or after completion.

**CANCELLATION AND ORDER CHANGES - FEES**

Acknowledged orders are considered firm orders and therefore not subject to cancellation or change. However, in the event we are able to stop an order prior to manufacturing process, we will consider cancellation or changes with a reprocessing fee of \$40.00 Net. Exceptions: Quickship orders cannot be changed or canceled after the 3rd business date after acknowledgment. Qualified changes/cancellations will be assessed a \$40.00 Net processing fee.

Changes or cancellation of order with special options or custom quoted items are also subject to additional material and vendor fee costs, plus a DARRAN special/custom reprocessing fee of \$100 NET.

**ORDER MOVEUPS**

Should an original scheduled ship date need to be improved, the Factory must be contacted 15 business days prior to the desired ship date. Move ups are subject to schedule availability.

**ORDER ACKNOWLEDGMENT**

Upon credit approval your order will be acknowledged and identified by an order number. When making reference to your order, please use this order number. Your acknowledgment is a detailed description of our interpretation of your order, pricing, shipping information, and estimated delivery date.

If you have not received an Acknowledgment within 10 Days of order issue, contact Customer Service immediately. All Quick Ship order acknowledgments will be faxed or emailed upon request to speed processing. Please read your acknowledgment carefully for correctness and notify DARRAN immediately of any discrepancies. Failure to notify relieves DARRAN from error liability.

Order acknowledgment is the final agreement between DARRAN and the customer superseding all previous communications regarding the order. DARRAN will not be responsible for errors made on orders placed by phone without written confirmation.

**SELLING INFORMATION**

Possession of this price list does not in itself constitute the right to sell DARRAN products. DARRAN products are sold and distributed through authorized dealerships. Contact factory for a listing of local representatives and dealerships.

**INVOICE TERMS**

Standard terms are NET 30 days. Finance charges of 1-1/2% will be added to delinquent accounts after 45 Days and for each 30 Days thereafter until paid.

Complaints involving newly received merchandise must be reported within 10 days from receipt to qualify for full invoice remittance suspension or term extension. Otherwise only items in dispute can be suspended from payment of invoice within terms.

**WAREHOUSE/STORAGE**

DARRAN will determine order warehousing approvals on a case by case basis. Orders that can be accommodated will be limited to a max of 30 days storage and must be invoiced at time of storage. Orders that exceed factory storage capacity will be transferred to local storage facilities subject to current storage rates and handling-transit charges. Storage charges must be paid prior to order release to shipping.



**EXECUTIVE OFFICE & CONFERENCE ROOM  
FURNITURE**

**November 3, 2015 through November 2, 2020**

FSC Group 71

GSA CONTRACT NUMBER: GS-27F-001DA

Business Classification:

WBENC Certified Woman-Owned Small Business

DARRAN FURNITURE INDUSTRIES

2402 SHORE DRIVE

HIGH POINT, NC 27263

336.861.2400 FAX 336.861.6485

Business Classification:

Woman-Owned Small Business

On-line access to contract ordering information, terms and conditions, up-to-date pricing, and the option to create an electronic delivery order are available through GSA Advantage!, a menu driven database system. The INTERNET address for GSA Advantage is <http://www.fss.gsa.gov>

For more information on ordering from Federal Supply Schedules click on the FSS Schedules button at <http://www.fss.gsa.gov>

**1a. Special Item Number**

711-8: Executive Office Furniture

711-9: Executive Conference Room Furniture

711-11: Tables and Accessories

711-16: Upholstered Seating

711-18: Multi-purpose Seating

**2. Maximum Order Limitations:**

711-8 \$500,000

711-9 \$500,000

711-11 \$500,000

711-16 \$300,000

711-18 \$200,000

**3. Minimum Order: \$100**

**4. Geographic Coverage:** 48 Contiguous States and the District of Columbia

**5. Point of Production:** High Point, North Carolina (Randolph County)

**6. Discount:** Prices shown herein are List (Discount is 56.9% Off List)

**7. Quantity Discounts:**

• \$467,837 List to \$1,000,000 List = 59.70%

• \$1,000,001 List to \$1,315,789 List = 61.70%

**8. Payment Terms:** ½% - Net 15 Days, Net 30 Days

**8a. Terms and Conditions of Government Credit Card Acceptance:**

a. No discount allowed for payment by Government Purchase Card

b. Provide commercial credit card number

c. Provide commercial credit card expiration date

d. Provide individual's name as it appears on

credit card

e. Provide telephone number of individual to whom credit is issued

**9a. Government Purchase Cards are accepted below the Micro Purchase Threshold.**

**9b. Government Purchase Cards are accepted above the Micro Purchase Threshold.**

**10. Foreign Terms:** None

**11a. Time of Delivery:** Regular Product: 60 - 90 days after receipt of order

Quick Ship Program: Contact DARRAN

**11b. Quick Ship Program:** Items available for expedited delivery are included in main Price Lists.

**11c. Overnight and 2-day delivery:** N/A

**11d. Urgent Requirements:** Will be considered on an individual basis. Contact DARRAN for details.

**12. FOB Point:** All destinations are limited to Commercial docks only. Carriers may refuse non-dock deliveries.

**12a. Freight Prices:**

a. All prices shown are suggested list prices with freight included where indicated.

b. Freight allows delivery to one qualified destination.

c. Within the Continental USA, all orders above \$1,500 net are shipped FOB factory, freight prepaid and allowed. All orders less than \$1,500 net will be subject to a \$100 net freight charge.

**13. Ordering Address:**

DARRAN Furniture Industries

P.O. Box 7614

High Point, NC 27264

Ph: 800.334.7891

Fax: 336.861.6485

**13a. Payment Address:**

BB&T

P.O. Box 890011

Charlotte, NC 28289-0011

**14. Warranty Provision:** Limited Lifetime (Contact DARRAN for details)

**15. Export Packing Charges:** Quoted on request

**13. Terms and Conditions: Order Cancellation / Changes.**

Restocking/Returns: No merchandise may be returned without a return authorization and shipping instructions. No credit or allowance will be given for repairs to defective materials unless DARRAN has given authority to make such repairs. A restocking charge of 25% will apply.

Cancellation: No cost prior to production. After

## GSA CUSTOMER INFORMATION

production has begun, only actual cost incurred will be billed to the Government that cannot be recovered through resale in 6 months

**14. Terms and Condition of Rental, Maintenance and Repair: Consult the Factory.**

**15. Terms and Conditions of Installation:** Installation by a Third party to be quoted on a per job basis. The ordering must specify what ranges of installation services are required.

**16. Terms and Conditions of Repair Parts:** Contact DARRAN for details.

**17. List of Service and distribution points:** Contact DARRAN for details..

**18. Preventative Maintenance:** Information enclosed with product.

**19. List of Participating Dealers:** Contact DARRAN for details.

**23. Environmental Attributes:** DARRAN is compliant with EPA standards. All plywood core material is CARB 2 compliant and contains recycled content. All DARRAN Casegood Products are BIFMA Level 2 Certified. DARRAN is FSC CoC Certified and our products are MAS Certified for Indoor Air Quality.

**23a. Recyclable and Recycled Content Packaging:** The corrugated packaging that is supplied to DARRAN, meets the federal mandate that requires the paperboard to be composed of 30%-50% recycled paper, and in some cases the recycled content is close to 100%.

**23b. Chemical Emission:** DARRAN finishes its products in an ENVI-CT Finish. (Environmental Coatings Technology). DARRAN's seating is finished with a low VOC Conversion Varnish and the casegoods are finished with a formaldehyde free, low VOC Urethane finish. These ENVI-CT finishes allow DARRAN's products to be MAS Certified Green under the ANSI BIFMA X7.1 Standard. Products assist with LEED 4.5 Credit.

**23c. Vapor Emissions:** DARRAN's ENVI-CT finishes use the latest environmental coatings technology to provide lasting durability and exceptional clarity with BACGUARD Silver anti-microbial protection built-in. The ENVI-CT finishes allows DARRAN casegoods to be MAS Certified Green meeting LEED Credit 4.5.

**24a. Duns Number:** 08-363-5318

**24b. Cage Code:** 0Y-6B6

**24c. Federal ID Number:** 56-117-1971

**24d. NAICS Code:** 337211

**25. SAM Network:** DARRAN is registered

## SHIPPING SCHEDULE

When requested, DARRAN will assist in locating special express carriers that may have short transit times. These services may exceed our prepaid freight costs; therefore, pricing is limited to the Freight Excluded formula with special express charges added to the invoice.

For special deliveries, DARRAN will make every effort to meet the appointed time; however DARRAN will not be responsible for any additional charges for late deliveries beyond our control.

## PRICES

- › All prices shown are suggested list prices with freight included where indicated.
- › Freight allows delivery to one qualified destination.
- › Within the Continental USA, all orders above \$1,500 net are shipped FOB factory, freight prepaid and allowed. All orders less than \$1,500 net will be subject to a \$100 net freight charge.

## CALL BEFORE DELIVERY REQUEST

DARRAN will arrange for carriers to call before delivery when requested.

Important Non-Qualified Destinations DARRAN Prepaid Freight Pricing does not include delivery to:

- › Residential Areas
- › Restricted Commercial Areas
- › No Dock Locations
- › Inside delivery/setup service

Orders received and installed without professional Furniture Installers voids all Warranty Coverage.

## CARRIER SELECTION

DARRAN selects and uses only carriers specialized in furniture transportation. Customer requested carriers can be authorized using Freight Excluded pricing with invoice add-on.

## SPECIFIC DELIVERY TIMES

DARRAN will assist in coordinating a requested delivery time from a carrier. DARRAN makes no guarantees and accepts no responsibility for such services as DARRAN has no control over possible carrier hazards. To ensure specific time arrival, we recommend arranging single stop, designated load carriers. Less than trailer load (LTL) shipments cannot be coordinated for a guaranteed delivery time.

## EXPRESS CARRIERS

When requested DARRAN will assist in locating special express carriers that may have short transit times. These services exceed our prepaid freight cost, therefore, pricing is limited to the Freight Excluded formula with special express charges added to invoice.

## FEATURES & ADVANTAGES

### VENEER AND HPL TOPS

Wood veneer tops and high-pressure laminate tops feature a M2 Grade, CARB2 MDF Core with balanced 3-ply construction. Tops are 1-5/16" thick on all veneer and HPL products except for the Rift Collection, which features 1-1/2" thick primary work surfaces. Tops are connected to chassis with steel angle brackets, wood cleats and dowels. DARRAN only uses HPVA A Grade Flat Cut Cherry, Maple, and Walnut Veneers that are book-matched and slip-matched. Rift-Cut White Oak and Quarter-Cut Ash are available as premium veneers. DARRAN's Rift Collection features a double-cut veneer in a rift-cut pattern for a clean linear aesthetic. Veneer tops feature shapeable MDF edges, 3/4", 1", or 3mm external solid hardwood bands based on collection and edge selection. HPL tops feature a laminate self edge, shapeable MDF edge, or a 3mm solid wood edge based on edge selection.

### CHASSIS & PEDESTAL CONSTRUCTION

All pedestals and chassis are constructed with 3/4" thick balanced 3-ply panels. Panels are securely fastened together using rails that are bored and doweled, glued, metal reinforcement brackets and wood cleat construction. Thick end panels are pre-bored to accept a tee nut for the adjustable glide and are reinforced with pvc banding to prevent glide tear out. Glue blocks are used where 3/4" thick panels are joined, bored for tee nut to accept adjustable glide.

### ADJUSTABLE GLIDES

Glides provide 1" of vertical leveling adjustment. Glide bottom is durable metal.

### DRAWERS

All drawers are constructed of four sides and a bottom, which are attached to a drawer front with screws for easy removal. Drawer fronts feature vertically matched veneer within each pedestal. Pencil trays are standard in all box drawers. Jamestown, Prado, Rift, and Spaces feature maple veneer 1/2" thick material for drawer sides, fronts and backs with a UV finish for maximum durability. Drawer bottoms are 7/32" thick 3-ply maple veneer. Drawer boxes are assemble at each corner with dowel joinery for maximum drawer strength. Capitol Park, Central Park, NSsq, Reception Park, and Richmond Park feature drawers that are 1/2" thick wood grained wrapped 5 sided miter-folded construction with 1/8" thick hardboard bottoms.

### SUSPENSIONS

All caseloads utilize cold rolled steel zinc plated high-grade drawer suspensions. All suspensions are warranted for the lifetime of the product. Box and File drawers are full extension, featuring steel ball bearings for a smoother quieter range of motion with soft close operation and are rated 100lbs. Lateral file drawers are a progressive action full extension suspension with the soft close operation and is rated at 150lbs. Lateral files include anti tip mechanism that will allow only one drawer at a time to be opened.

### HINGES

Units with doors include 95 degree swing hinges.

### FILING

Capitol Park, Central Park, NSsq, Reception Park, and Richmond Park feature a highly durable black plastic extrusion that is securely fastened into a route on top of the drawer.

Desk drawers are provided with a cross bar that allows for adjustability for letter or legal filing side to side, letter width filing front to back without the use of a cross bar. Credenza and Return filing is letter width front to back and legal width side to side without the use of a cross bar, letter width side to side with the use of a cross bar. Lateral files feature legal with filing side to side and two rows of letter width front to back with the use of cross bars.

Jamestown, Prado, Rift, and Spaces feature metal file frames around the perimeter of the drawers with cross bars. Desk drawers are provided with a cross bar that allows for adjustability for letter or legal filing side to side, letter width filing front to back without the use of a cross bar. . Legal width drawers are specified on desks 72" and larger, and filing is legal front to back or two rows letter side to side. Credenza and Return filing is letter width front to back and legal width side to side without the use of a cross bar, letter width side to side with the use of a cross bar. Lateral files feature legal with filing side to side and two rows of letter width front to back with the use of cross bars.

### LOCKS

Silver, black or bronze face locks are standard on all desks, credenzas, returns, and modular pedestals and match the color of the pull selection. Locks are optional on door storage, overhead storage, towers with doors and all door units. Each drawer pedestal is independently locked. Lock plugs are factory or field installed.

### KEYING

Keying is available either factory or field installed. Factory installed keying offers two options: random or designated. When the random keying option is selected an arbitrary key number will be assigned to the unit. When the designated keying option is selected a key number must be specified between 101 and 110. Higher numbers may be specified if noted on the purchase order and may be factory or field installed. Black and silver face lock have silver keys and bronze face locks have brass keys.

### WIRE MANAGEMENT

Wire management capabilities include standard and optional worksurface grommets. When grommets are standard or specified in a unit, wire channels under the surface are provided for organization and management of all communication wires and cords.

### GROMMETS

Metal grommets are provided to match the drawer pull selection. Grommet is available in black, silver, white or antique brass. Must specify standard or non-standard location. Black plastic grommets are available as an option for vertical applications.

**POWERPORTS**

A large selection of powerports are available and handle power, data, docking stations and communication. See options section for selection.

**FINISHES**

**"W" VENEER**  
Veneer

**"G" LAMINATE HPL TOPS**  
HPL

**"M" THERMALLY FUSED LAMINATE**  
TFL

WAC Amber Cherry .....	GAC Amber Cherry .....	N/A
WRC Caramel Cherry.....	N/A	
WIC Crimson Cherry .....	GIC Crimson Cherry	
WEC Ebony Cherry .....	N/A	
WHC Honey Cherry.....	GHC Honey Cherry	
WOC Koko Cherry.....	GOC Koko Cherry	
WSC Scotch Cherry .....	N/A	
WCM Clear Maple .....	GCM Clear Maple	
WWM Wheat Maple.....	GWM Wheat Maple	
WEW Executive Walnut.....	GEW Executive Walnut	
WRW Gray Luster Walnut .....	GRW Gray Luster Walnut	
WGW Gunstock Walnut.....	N/A	
WJW Judicial Walnut.....	N/A	
WNW Natural Walnut.....	GNW Natural Walnut	
WTW Studio Teak Walnut.....	GTW Studio Teak Walnut	

Send 3x3 or larger finish chip for color match. Custom finish upcharge is 3% or \$250 Net (whichever is greater).

**FINISH**

ENVI-CT Green Certified European Technology Coatings Finish with Anti-microbial protection.

**VENEER AND HPL TOPS**

Wood veneer tops and high-pressure laminate tops feature a M2 Grade, CARB2 MDF Core with balanced 3-ply construction. Tops are 1-5/16" thick on all veneer and HPL products except for the Rift Collection, which features 1-1/2" thick primary work surfaces. Tops are connected to chassis with steel angle brackets, wood cleats and dowels. DARRAN only uses HPVA A Grade Flat Cut Cherry, Maple, and Walnut Veneers that are book-matched and slip-matched. Rift-Cut White Oak and Quarter-Cut Ash are available as premium veneers. DARRAN's Rift Collection features a double-cut veneer in a rift-cut pattern for a clean linear aesthetic. Veneer tops feature shapeable MDF edges, 3/4", 1", or 3mm external solid hardwood bands based on collection and edge selection. HPL tops feature a laminate self edge, shapeable MDF edge, or a 3mm solid wood edge based on edge selection.

**CHASSIS**

3/4" thick core, Medium Density Fiberboard (MDF) rated EPP/SCS/CARB-II material with 3 ply balanced construction. Pedestal and cabinets feature dowel construction reinforced with steel bracket plates, wood cleats, screws and glue. Exposed interiors feature finished veneer of same species as exterior faces. Panel molding standard on approach and end panels of all worksurface height units.

NOTE: All units are standard with 1" adjustable glides that allow for leveling of units.

**DRAWER FRONTS**

Drawer fronts are vertically matched in balanced sets. Doors feature vertical veneer bookmatched horizontally in sets of 2 / 4 and 6 doors. All drawers and doors have traditional scallop profile edge shape. All tower fronts matched in vertical sets.

**DRAWERS**

Drawers feature mitre joint / dowel construction with a natural maple finish. All drawers extend 100% for full access on steel ball bearing slides with cushion in-out stops. Drawers have been tested and passed BIFMA 50,000 cycle test. File drawers feature 1/4" bottoms reinforced for heavy weight capacity. All drawers are guaranteed lifetime with free replacement warranty.

**OPTIONAL WOOD DRAWERS**

Optional hardwood veneer plywood drawers feature banded top and bottom edges for smoothness. Drawers are dowel joint construction with a UV cured finish over maple veneers, plus a lifetime free replacement guarantee. Optional Wood Drawer (Any Size) – Option Code P33...\$40 List Price Per Drawer

**RANDOM LOCKS & KEYING (STANDARD)**

Locks are standard on all storage units below the worksurface. Random lock cores are installed at the factory. Some units may be shipped with the same key number. Locks are Silver, Black or Bronze and match pull finish unless specified.

- SRK: Random Silver Random Key - n/c
- BRK: Random Black Random Key - n/c
- ZRK: Random Bronze Random Key - n/c

**FIELD INSTALLED LOCKS & KEYING (OPTION)**

Field installed lock option can be selected, each unit is shipped with an empty lock cylinder. A separate line item must be ordered to receive the numbered lock cores for field installation. Field installed locks are available at no additional charge. Specify Silver or Black Locks.

- SFK: Field Installed Silver Random Key - n/c
- BFK: Field Installed Black Random Key - n/c
- ZFK: Field Installed Bronze Random Key - n/c

**STANDARD PROFILE**

Reception Park Edge  
 Hardwood Rim Band Species Same As Surface Veneer

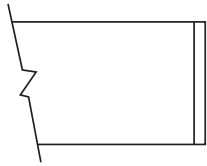

**FLAT**  
 3mm solid  
 hardwood band

**COUNTERTOPS**

Knife Edge - Standard Edge No additional upcharge  
 Flat Edge - Optional Edge - No additional upcharge

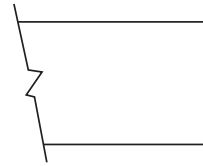

**FLAT**  
 "W" or Solid Surface

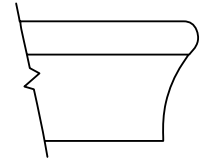

**KNIFE**  
 "W" "G"

Choice of veneer, laminate or solid surface  
 countertops.

**PULLS**

Factory Installed

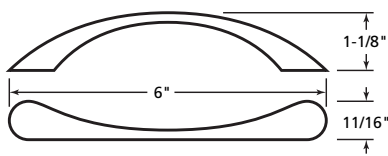

PL-105 Matte Black  
 PL-106 Matte Nickel

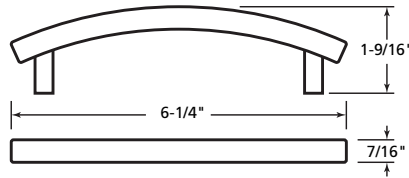

PL-112 Matte Black  
 PL-113 Matte Nickel

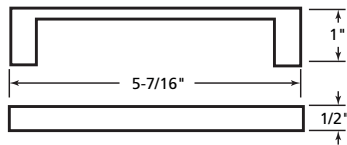

PL-115 Matte Black  
 PL-116 Matte Nickel

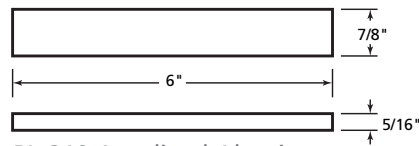

PL-210 Anodized Aluminum

**OPTIONAL GROMMETS**

Factory Installed

Grommets (Standard Location)

Specify Color and Left/Right/Center - \$45 ea.

- Black: TM30-R (Right), TM30-L (Left), TM30-C (Center)
- Silver: TM31-R (Right), TM31-L (Left), TM31-C (Center)
- Antique Brass: TM33-R (Right), TM33-L (Left), TM33-C (Center)

Grommets (Non-Standard Location)

Provide drawing w/ Grommet Location and Specify Color - \$90 ea.

- Black: TM30-NS
- Silver: TM31-NS
- Antique Brass: TM33-NS

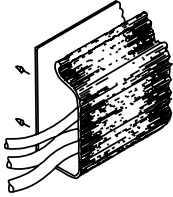

Horizontal J-Channel wire management (Sku: W-1) is sold separately to conceal wire under worksurfaces.

W1



**GROMMETS (VERTICAL SURFACE)**

Standard Location - \$45 ea.

- Black Plastic Vertical Surface: TM50-C (Bottom Center)

Non-Standard Location - \$90 ea.

- Black Plastic Vertical Surface: TM50-NS

**STANDARD GROMMET LOCATION REFERENCE**



Bridge

Center Grommet



Return (Left Pedestal Shown)

Right Pedestal - Left Grommet

Left Pedestal - Right Grommet



HEIGHT REFERENCE

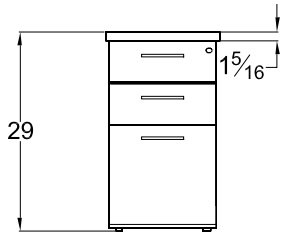

Pedestal Front Profile  
Box/Box/File

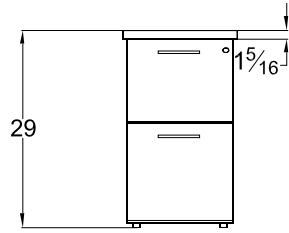

Pedestal Front Profile  
File/File

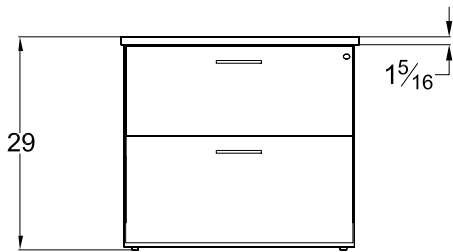

Pedestal Front Profile  
Lateral File

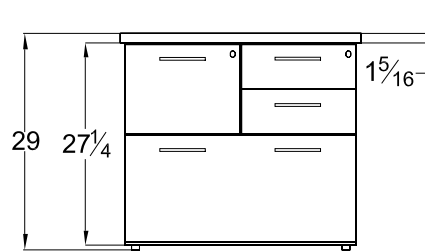

Pedestal Front Profile  
Multi-File

**COUNTER SUPPORT POST**

3" Diameter, 16 gauge steel post. Bolted through lower worksurface. Tops provide rigid counter mounting. Powder coat finish in matte nickel.

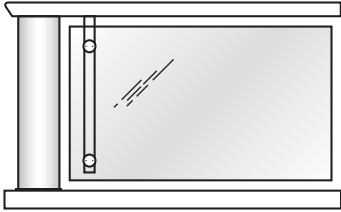

**PRIVACY SCREEN DETAIL**

Frosted Acrylic panels are suspended between countertops and worksurfaces with matte nickel rods and fasteners. Panels float between support post and surfaces. Panels are curved to match curved surfaces. Edges and corners are rounded.

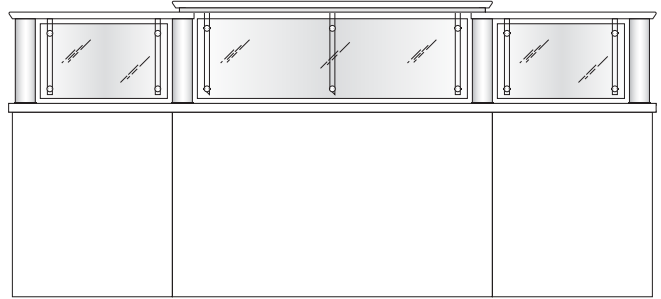

**PRIVACY SCREEN DETAIL**

Acrylic Screen is fastened to matte nickel rod and sleeve collar with matte nickel screw caps.

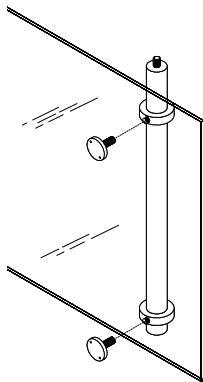

**APPROACH VIEW**

1" space provides a floating appearance

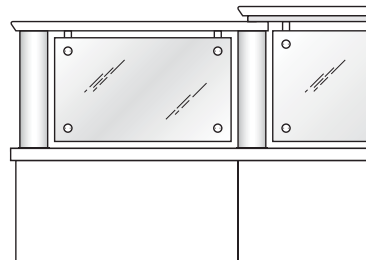

**USER VIEW**

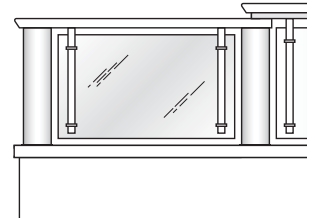

**GRAIN DIRECTION**

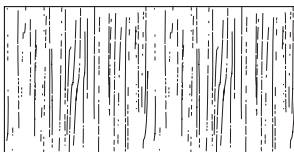

Bridge

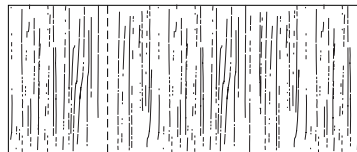

Return



Credenza

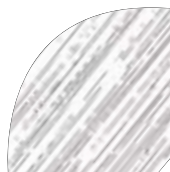

Corner

**INTERIOR DRAWER DIMENSIONS**

UNIT DEPTH	DRAWER TYPE	OVERALL DIMENSIONS			INTERIOR DRAWER DIMENSIONS		
		W	D	H	W	D	H
15-5/8" Letter	24" Box	13-1/8	16-1/16	4	12-1/8	15-1/16	3-7/16
	24" File	13-1/8	16-1/16	9-13/16	12-1/8	15-1/16	9-5/16
29" Lateral	24" File	26-1/2	16-1/16	9-13/16	25-1/2	15-1/16	9-5/16
35" Lateral	24" File	32-1/2	16-1/16	9-13/16	31-1/2	15-1/16	9-5/16

**FILING REFERENCE**

**FILING FOR 24" DEPTH UNITS**

13 1/8" Wide File Drawer - 16 1/16" Deep

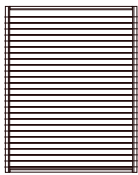

Letter Front to Back

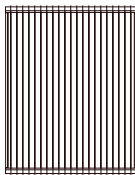

Legal Side to Side  
with File Rail

**29" LATERAL FILE DRAWER**

26-1/2" Wide File Drawer - 16-1/16" Deep

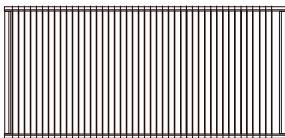

Legal Side to Side

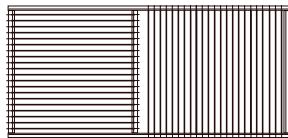

Legal Side to Side  
with File Rail

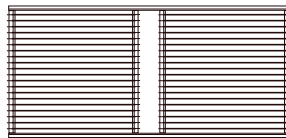

Letter Front to Back  
with File Rail

**35" LATERAL FILE DRAWER**

32-1/2" Wide File Drawer - 16-1/16" Deep

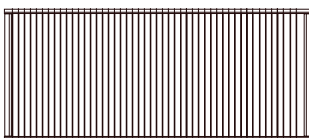

Legal Side to Side

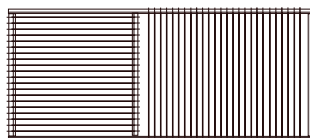

Legal Side to Side  
Letter Front to Back  
with File Rail

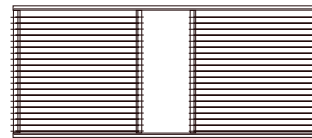

Letter Front to Back  
with File Rail

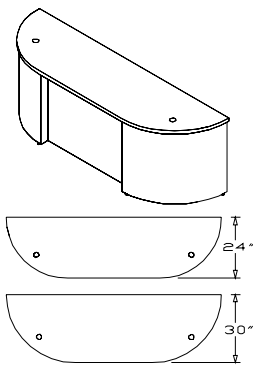

**CURVED RECEPTION DESK**

**STANDARD FEATURES**

- 2 Standard grommets - matches pull finish or specify black TM30 or silver TM31
- Storage shelf
- Wire management channels

**NOTES**

- "U" Reception Stations require minimum 84" to ensure adequate kneespace area.

[CLICK HERE TO VIEW PRODUCT INDEX](#)

**1 SELECT A STYLE**

DIMENSIONS		STYLE NUMBER	LIST PRICE	STYLE NUMBER	LIST PRICE	STYLE NUMBER	LIST PRICE
W" x D" x H"	WGT	"W" Veneer Top Veneer Chassis		"G" HPL High Pressure Laminate Top Veneer Chassis		"M" TFL Thermally Fused Laminate Top Thermally Fused Laminate Chassis	
<b>30" Depth</b>							
96 x 30 x 29	250	CRP9630DS024W	4516	CRP9630DS024G	4516	"M" Option N/A	
90 x 30 x 29	240	CRP9030DS024W	4069	CRP9030DS024G	4069	"M" Option N/A	
84 x 30 x 29	200	CRP8430DS024W	3765	CRP8430DS024G	3765	"M" Option N/A	
78 x 30 x 29	190	CRP7830DS024W	3551	CRP7830DS024G	3551	"M" Option N/A	
72 x 30 x 29	175	CRP7230DS024W	3320	CRP7230DS024G	3320	"M" Option N/A	
<b>24" Depth</b>							
96 x 24 x 29	210	CRP9624DS024W	4140	CRP9624DS024G	4140	"M" Option N/A	
90 x 24 x 29	200	CRP9024DS024W	3694	CRP9024DS024G	3694	"M" Option N/A	
84 x 24 x 29	170	CRP8424DS024W	3342	CRP8424DS024G	3342	"M" Option N/A	
78 x 24 x 29	160	CRP7824DS024W	3177	CRP7824DS024G	3177	"M" Option N/A	
72 x 24 x 29	150	CRP7224DS024W	2945	CRP7224DS024G	2945	"M" Option N/A	

**2 SELECT A FINISH**

"W" Veneer	"G" HPL	"M" TFL	
WAC	GAC	-	Amber Cherry
WRC	-	-	Caramel Cherry
WIC	GIC	-	Crimson Cherry
WEC	-	-	Ebony Cherry
WHC	GHC	-	Honey Cherry
WOC	GOC	-	KoKo Cherry
WSC	-	-	Scotch Cherry
WCM	GCM	-	Clear Maple
WWM	GWM	-	Wheat Maple
WEW	GEW	-	Executive Walnut
WRW	-	-	Gray Luster Walnut
WGW	-	-	Gunstock Walnut
WJW	-	-	Judicial Walnut
WNW	GNW	-	Natural Walnut
WTW	GTW	-	Studio Teak Walnut
WWP	GWL	-	Designer White

**3 SELECT AN EDGE**



Flat 3 mm

**4 SELECT HARDWARE**

Hardware Option Not Available

**5 OPTIONS**

**ACCESSORIES**

- K18: CPU Retractable Cradle - \$195
- K28: Articulating Keyboard w/ Mouse - \$375
- K31: Center Drawer - \$195

**GROMMETS (NON-STANDARD LOCATION)**

- Provide drawing w/ Grommet Location and Specify Color - \$90 ea.
- Black: TM30-NS
- Silver: TM31-NS

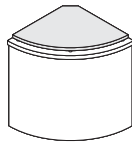
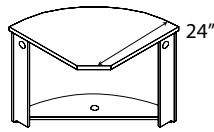
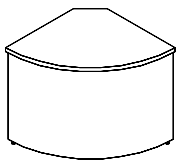

CVC3030 Option

**CURVED "V" CORNER**

**STANDARD FEATURES**

- 1 Standard grommet - matches pull finish or specify black TM30 or silver TM31
- Grommet standard in storage shelf for wire access to the floor
- Storage shelf
- Wire management grommets & channels

**NOTES**

- For 24" D Return Hookup

[CLICK HERE TO VIEW PRODUCT INDEX](#)

**1 SELECT A STYLE**

DIMENSIONS		STYLE NUMBER	LIST PRICE	STYLE NUMBER	LIST PRICE	STYLE NUMBER	LIST PRICE
W" x D" x H"	WGT	<b>"W"</b> Veneer Top Veneer Chassis		<b>"G"</b> High Pressure Laminate Top Veneer Chassis		<b>"M"</b> Thermally Fused Laminate Top Thermally Fused Laminate Chassis	
30 x 30 x 29	95	CRP3030CU237W	1707	CRP3030CU237G	1707	"M"Option N/A	

**2 SELECT A FINISH**

"W" Veneer	"G" HPL	"M" TFL	
WAC	GAC	-	Amber Cherry
WRC	-	-	Caramel Cherry
WIC	GIC	-	Crimson Cherry
WEC	-	-	Ebony Cherry
WHC	GHC	-	Honey Cherry
WOC	GOC	-	KoKo Cherry
WSC	-	-	Scotch Cherry
WCM	GCM	-	Clear Maple
WWM	GWM	-	Wheat Maple
WEW	GEW	-	Executive Walnut
WRW	-	-	Gray Luster Walnut
WGW	-	-	Gunstock Walnut
WJW	-	-	Judicial Walnut
WNW	GNW	-	Natural Walnut
WTW	GTW	-	Studio Teak Walnut
WWP	GWL	-	Designer White

**3 SELECT AN EDGE**



Flat 3 mm

**4 SELECT HARDWARE**

Hardware Option Not Available

**5 OPTIONS**

- GROMMETS (STANDARD LOCATION)**  
Specify Color and Left/Right/Center - \$45 ea.  
- Black: TM30-R (Right), TM30-L (Left), TM30-C (Center)  
- Silver: TM31-R (Right), TM31-L (Left), TM31-C (Center)
- GROMMETS (NON-STANDARD LOCATION)**  
Provide drawing w/ Grommet Location and Specify Color - \$90 ea.  
- Black: TM30-NS  
- Silver: TM31-NS
- SOLID SURFACE TOP**  
Solid Surface: Black pear G10, sea oat quartz G38, white quartz G4  
- SS3030: Curved "V" corner accent top - \$1530  
- CV3030: "W" veneer "G" HPL curved "V" corner accent top - \$525

RECEPTION WORKSTATION RETURNS 24" D

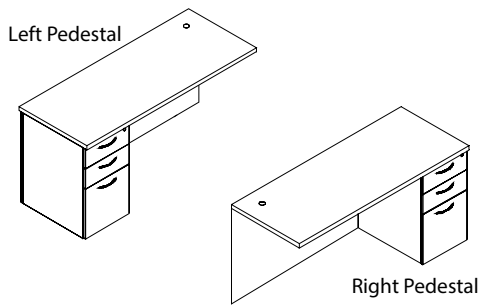

RETURN - BOX/BOX/FILE

STANDARD FEATURES

- 1 Standard grommet - matches pull finish or specify black TM30 or silver TM31
- Full extension drawers - locking
- Full fixed modesty
- Soft close suspension drawer(s)
- Wire management channel

NOTES

- Hinged modesty n/a on reception

[CLICK HERE TO VIEW PRODUCT INDEX](#)

**1 SELECT A STYLE**

DIMENSIONS		STYLE NUMBER	LIST PRICE	STYLE NUMBER	LIST PRICE	STYLE NUMBER	LIST PRICE
W" x D" x H"	WGT	"W" Veneer Top Veneer Chassis		"G" HPL High Pressure Laminate Top Veneer Chassis		"M" TFL Thermally Fused Laminate Top Thermally Fused Laminate Chassis	
<b>Left Pedestal</b>							
60 x 24 x 29	175	CRP6024RE207W	2136	CRP6024RE207G	2136	"M" Option N/A	
54 x 24 x 29	165	CRP5424RE207W	2071	CRP5424RE207G	2071	"M" Option N/A	
48 x 24 x 29	155	CRP4824RE207W	2001	CRP4824RE207G	2001	"M" Option N/A	
42 x 24 x 29	145	CRP4224RE207W	1963	CRP4224RE207G	1963	"M" Option N/A	
36 x 24 x 29	135	CRP3624RE207W	1936	CRP3624RE207G	1936	"M" Option N/A	
<b>Right Pedestal</b>							
60 x 24 x 29	175	CRP6024RE209W	2136	CRP6024RE209G	2136	"M" Option N/A	
54 x 24 x 29	165	CRP5424RE209W	2071	CRP5424RE209G	2071	"M" Option N/A	
48 x 24 x 29	155	CRP4824RE209W	2001	CRP4824RE209G	2001	"M" Option N/A	
42 x 24 x 29	145	CRP4224RE209W	1963	CRP4224RE209G	1963	"M" Option N/A	
36 x 24 x 29	135	CRP3624RE209W	1936	CRP3624RE209G	1936	"M" Option N/A	

**2 SELECT A FINISH**

"W" Veneer	"G" HPL	"M" TFL	
WAC	GAC	-	Amber Cherry
WRC	-	-	Caramel Cherry
WIC	GIC	-	Crimson Cherry
WEC	-	-	Ebony Cherry
WHC	GHC	-	Honey Cherry
WOC	GOC	-	KoKo Cherry
WSC	-	-	Scotch Cherry
WCM	GCM	-	Clear Maple
WWM	GWM	-	Wheat Maple
WEW	GEW	-	Executive Walnut
WRW	-	-	Gray Luster Walnut
WGW	-	-	Gunstock Walnut
WJW	-	-	Judicial Walnut
WNW	GNW	-	Natural Walnut
WTW	GTW	-	Studio Teak Walnut
WWP	GWL	-	Designer White

**3 SELECT AN EDGE**



Flat 3 mm

**5 OPTIONS**

ACCESSORIES

- K28: Articulating Keyboard w/ Mouse - \$375
- K18: CPU Retractable Cradle - \$195

DRAWERS

- P33: Wood Drawer Upgrade - \$40 per drawer
- P40W: extra Box/Box/File or File/File to Kneespace - \$875

GROMMETS (NON-STANDARD LOCATION)

Provide drawing w/ Grommet Location and Specify Color - \$90 ea.  
 - Black: TM30-NS  
 - Silver: TM31-NS

**4 SELECT HARDWARE**

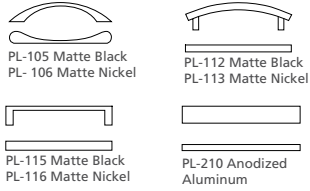

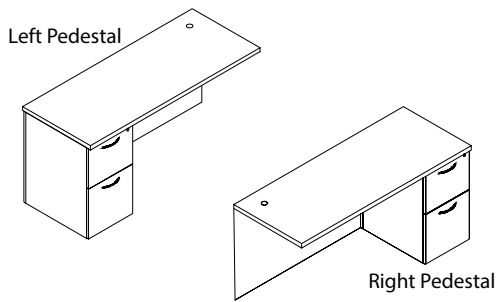

**RETURN**

**STANDARD FEATURES**

- 1 Standard grommet - matches pull finish or specify black TM30 or silver TM31
- Full extension drawers - locking
- Full fixed modesty
- Soft close suspension drawer(s)
- Wire management channel

**NOTES**

- Hinged modesty n/a on reception

[CLICK HERE TO VIEW PRODUCT INDEX](#)

**1 SELECT A STYLE**

DIMENSIONS		STYLE NUMBER	LIST PRICE	STYLE NUMBER	LIST PRICE	STYLE NUMBER	LIST PRICE
W" x D" x H"	WGT	"W" Veneer Top Veneer Chassis		"G" HPL High Pressure Laminate Top Veneer Chassis		"M" TFL Thermally Fused Laminate Top Thermally Fused Laminate Chassis	
<b>Left Pedestal</b>							
60 x 24 x 29	175	CRP6024RE195W	2136	CRP6024RE195G	2136	"M" Option N/A	
54 x 24 x 29	165	CRP5424RE195W	2071	CRP5424RE195G	2071	"M" Option N/A	
48 x 24 x 29	155	CRP4824RE195W	2001	CRP4824RE195G	2001	"M" Option N/A	
42 x 24 x 29	145	CRP4224RE195W	1963	CRP4224RE195G	1963	"M" Option N/A	
36 x 24 x 29	135	CRP3624RE195W	1936	CRP3624RE195G	1936	"M" Option N/A	
<b>Right Pedestal</b>							
60 x 24 x 29	175	CRP6024RE196W	2136	CRP6024RE196G	2136	"M" Option N/A	
54 x 24 x 29	165	CRP5424RE196W	2071	CRP5424RE196G	2071	"M" Option N/A	
48 x 24 x 29	155	CRP4824RE196W	2001	CRP4824RE196G	2001	"M" Option N/A	
42 x 24 x 29	145	CRP4224RE196W	1963	CRP4224RE196G	1963	"M" Option N/A	
36 x 24 x 29	135	CRP3624RE196W	1936	CRP3624RE196G	1936	"M" Option N/A	

**2 SELECT A FINISH**

"W" Veneer	"G" HPL	"M" TFL	
WAC	GAC	-	Amber Cherry
WRC	-	-	Caramel Cherry
WIC	GIC	-	Crimson Cherry
WEC	-	-	Ebony Cherry
WHC	GHC	-	Honey Cherry
WOC	GOC	-	KoKo Cherry
WSC	-	-	Scotch Cherry
WCM	GCM	-	Clear Maple
WWM	GWM	-	Wheat Maple
WEW	GEW	-	Executive Walnut
WRW	-	-	Gray Luster Walnut
WGW	-	-	Gunstock Walnut
WJW	-	-	Judicial Walnut
WNW	GNW	-	Natural Walnut
WTW	GTW	-	Studio Teak Walnut
WWP	GWL	-	Designer White

**3 SELECT AN EDGE**



**5 OPTIONS**

- ACCESSORIES**
- K28: Articulating Keyboard w/ Mouse - \$375
  - K18: CPU Retractable Cradle - \$195
- DRAWERS**
- P33: Wood Drawer Upgrade - \$40 per drawer
  - P40W: extra Box/Box/File or File/File to Kneespace - \$875
- GROMMETS (NON-STANDARD LOCATION)**
- Provide drawing w/ Grommet Location and Specify Color - \$90 ea.
- Black: TM30-NS
  - Silver: TM31-NS

**4 SELECT HARDWARE**

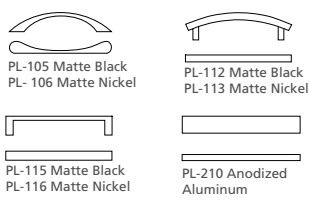



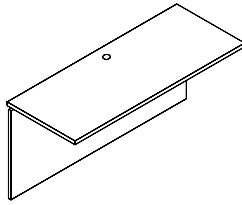

**BRIDGE**

**STANDARD FEATURES**

- Full fixed modesty
- 1 Standard grommet - matches pull finish or specify black TM30 or silver TM31

[CLICK HERE TO VIEW PRODUCT INDEX](#)

**1 SELECT A STYLE**

DIMENSIONS		STYLE NUMBER	LIST PRICE	STYLE NUMBER	LIST PRICE	STYLE NUMBER	LIST PRICE
W" x D" x H"	WGT	"W" Veneer Veneer Top Veneer Chassis		"G" HPL High Pressure Laminate Top Veneer Chassis		"M" TFL Thermally Fused Laminate Top Thermally Fused Laminate Chassis	
72 x 24 x 29	145	CRP7224BR150W	1136	CRP7224BR150G	1136	"M"Option N/A	
66 x 24 x 29	120	CRP6624BR150W	1012	CRP6624BR150G	1012	"M" Option N/A	
60 x 24 x 29	105	CRP6024BR150W	886	CRP6024BR150G	886	"M" Option N/A	
54 x 24 x 29	100	CRP5424BR150W	738	CRP5424BR150G	738	"M" Option N/A	
48 x 24 x 29	90	CRP4824BR150W	679	CRP4824BR150G	679	"M" Option N/A	
42 x 24 x 29	85	CRP4224BR150W	655	CRP4224BR150G	655	"M" Option N/A	

**2 SELECT A FINISH**

"W" Veneer	"G" HPL	"M" TFL	
WAC	GAC	-	Amber Cherry
WRC	-	-	Caramel Cherry
WIC	GIC	-	Crimson Cherry
WEC	-	-	Ebony Cherry
WHC	GHC	-	Honey Cherry
WOC	GOC	-	KoKo Cherry
WSC	-	-	Scotch Cherry
WCM	GCM	-	Clear Maple
WWM	GWM	-	Wheat Maple
WEW	GEW	-	Executive Walnut
WRW	-	-	Gray Luster Walnut
WGW	-	-	Gunstock Walnut
WJW	-	-	Judicial Walnut
WNW	GNW	-	Natural Walnut
WTW	GTW	-	Studio Teak Walnut
WWP	GWL	-	Designer White

**3 SELECT AN EDGE**



**5 OPTIONS**

- ACCESSORIES**
- K28: Articulating Keyboard w/ Mouse - \$375
  - K18: CPU Retractable Cradle - \$195
- GROMMETS (NON-STANDARD LOCATION)**
- Provide drawing w/ Grommet Location and Specify Color - \$90 ea.
- Black: TM30-NS
  - Silver: TM31-NS
- MODESTY**
- M34T: "W" "G" Style Drop Door Tech Modesty - \$125
  - M51: Open Back Modesty with Wire Mgmt Rail - Deduct \$95

**4 SELECT HARDWARE**

Hardware Option Not Available

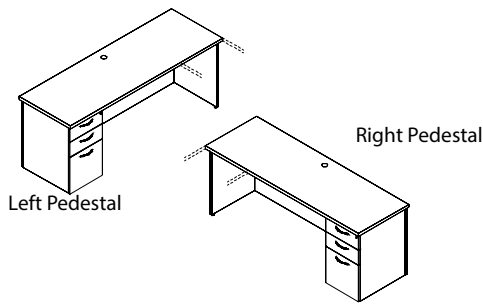

**BOX/BOX/FILE**

**STANDARD FEATURES**

- Full extension drawers - locking
- Fully finished back for open plan
- Full veneer modesty
- 1 Standard grommet - matches pull finish or specify black TM30 or silver TM31
- Soft close suspension drawer(s)

**NOTES**

- Keyboard not available on 60" units.

[CLICK HERE TO VIEW PRODUCT INDEX](#)

**1 SELECT A STYLE**

DIMENSIONS		STYLE NUMBER	LIST PRICE	STYLE NUMBER	LIST PRICE	STYLE NUMBER	LIST PRICE
W" x D" x H"	WGT	"W" Veneer Top Veneer Chassis		"G" High Pressure Laminate Top Veneer Chassis		"M" Thermally Fused Laminate Top Thermally Fused Laminate Chassis	
<b>Left Pedestal</b>							
84 x 24 x 29	250	CRP8424CA936W	2647	CRP8424CA936G	2647	"M" Option N/A	
72 x 24 x 29	240	CRP7224CA936W	2342	CRP7224CA936G	2342	"M" Option N/A	
66 x 24 x 29	225	CRP6624CA936W	2298	CRP6624CA936G	2298	"M" Option N/A	
60 x 24 x 29	210	CRP6024CA936W	2284	CRP6024CA936G	2284	"M" Option N/A	
<b>Right Pedestal</b>							
84 x 24 x 29	250	CRP8424CA937W	2647	CRP8424CA937G	2647	"M" Option N/A	
72 x 24 x 29	240	CRP7224CA937W	2342	CRP7224CA937G	2342	"M" Option N/A	
66 x 24 x 29	225	CRP6624CA937W	2298	CRP6624CA937G	2298	"M" Option N/A	
60 x 24 x 29	210	CRP6024CA937W	2284	CRP6024CA937G	2284	"M" Option N/A	

**2 SELECT A FINISH**

"W" Veneer	"G" HPL	"M" TFL	Finish
WAC	GAC	-	Amber Cherry
WRC	-	-	Caramel Cherry
WIC	GIC	-	Crimson Cherry
WEC	-	-	Ebony Cherry
WHC	GHC	-	Honey Cherry
WOC	GOC	-	KoKo Cherry
WSC	-	-	Scotch Cherry
WCM	GCM	-	Clear Maple
WWM	GWM	-	Wheat Maple
WEW	GEW	-	Executive Walnut
WRW	-	-	Gray Luster Walnut
WGW	-	-	Gunstock Walnut
WJW	-	-	Judicial Walnut
WNW	GNW	-	Natural Walnut
WTW	GTW	-	Studio Teak Walnut
WWP	GWL	-	Designer White

**3 SELECT AN EDGE**



**5 OPTIONS**

**ACCESSORIES**

- K28: Articulating Keyboard w/ Mouse - \$375
- K18: CPU Retractable Cradle - \$195

**DRAWERS**

- P33: Wood Drawer Upgrade - \$40 per drawer
- P40W: extra Box/Box/File or File/File to Kneespace - \$875

**GROMMETS (NON-STANDARD LOCATION)**

- Provide drawing w/ Grommet Location and Specify Color - \$90 ea.
- Black: TM30-N5
- Silver: TM31-N5

**MODESTY**

- M34T: "W" "G" Style Drop Door Tech Modesty - \$125
- M51: Open Back Modesty with Wire Mgmt Rail - Deduct \$95

**4 SELECT HARDWARE**

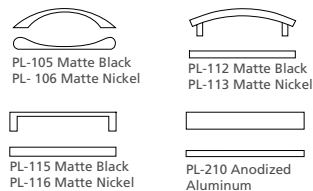

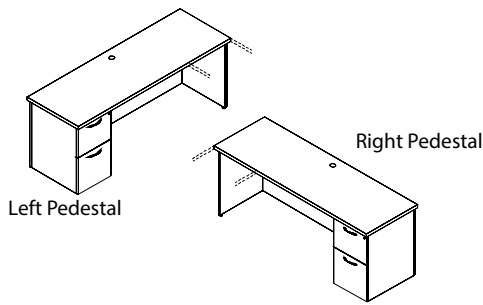

**FILE/FILE**

**STANDARD FEATURES**

- Full extension drawers - locking
- Fully finished back for open plan
- Full veneer modesty
- 1 Standard grommet - matches pull finish or specify black TM30 or silver TM31
- Soft close suspension drawer(s)

**NOTES**

- Keyboard not available on 60" units.

[CLICK HERE TO VIEW PRODUCT INDEX](#)

**1 SELECT A STYLE**

DIMENSIONS		STYLE NUMBER	LIST PRICE	STYLE NUMBER	LIST PRICE	STYLE NUMBER	LIST PRICE
W" x D" x H"	WGT	"W" Veneer Top Veneer Chassis		"G" High Pressure Laminate Top Veneer Chassis		"M" Thermally Fused Laminate Top Thermally Fused Laminate Chassis	
<b>Left Pedestal</b>							
84 x 24 x 29	250	CRP8424CA938W	2647	CRP8424CA938G	2647	"M" Option N/A	
72 x 24 x 29	240	CRP7224CA938W	2342	CRP7224CA938G	2342	"M" Option N/A	
66 x 24 x 29	225	CRP6624CA938W	2298	CRP6624CA938G	2298	"M" Option N/A	
60 x 24 x 29	210	CRP6024CA938W	2284	CRP6024CA938G	2284	"M" Option N/A	
<b>Right Pedestal</b>							
84 x 24 x 29	250	CRP8424CA939W	2647	CRP8424CA939G	2647	"M" Option N/A	
72 x 24 x 29	240	CRP7224CA939W	2342	CRP7224CA939G	2342	"M" Option N/A	
66 x 24 x 29	225	CRP6624CA939W	2298	CRP6624CA939G	2298	"M" Option N/A	
60 x 24 x 29	210	CRP6024CA939W	2284	CRP6024CA939G	2284	"M" Option N/A	

**2 SELECT A FINISH**

"W" Veneer	"G" HPL	"M" TFL	Finish
WAC	GAC	-	Amber Cherry
WRC	-	-	Caramel Cherry
WIC	GIC	-	Crimson Cherry
WEC	-	-	Ebony Cherry
WHC	GHC	-	Honey Cherry
WOC	GOC	-	KoKo Cherry
WSC	-	-	Scotch Cherry
WCM	GCM	-	Clear Maple
WWM	GWM	-	Wheat Maple
WEW	GEW	-	Executive Walnut
WRW	-	-	Gray Luster Walnut
WGW	-	-	Gunstock Walnut
WJW	-	-	Judicial Walnut
WNW	GNW	-	Natural Walnut
WTW	GTW	-	Studio Teak Walnut
WWP	GWL	-	Designer White

**3 SELECT AN EDGE**



**5 OPTIONS**

**ACCESSORIES**

- K28: Articulating Keyboard w/ Mouse - \$375
- K18: CPU Retractable Cradle - \$195

**DRAWERS**

- P33: Wood Drawer Upgrade - \$40 per drawer
- P40W: extra Box/Box/File or File/File to Kneespace - \$875

**GROMMETS (STANDARD LOCATION)**

- Specify Color - \$45 ea.
- Black: TM30-C (Center)
- Silver: TM31-C (Center)

**GROMMETS (NON-STANDARD LOCATION)**

- Provide drawing w/ Grommet Location and Specify Color - \$90 ea.
- Black: TM30-NS
- Silver: TM31-NS

**MODESTY**

- M34T: "W" "G" Style Drop Door Tech Modesty - \$125
- M51: Open Back Modesty with Wire Mgmt Rail - Deduct \$95

**4 SELECT HARDWARE**

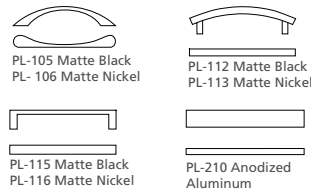

RECEPTION WORKSTATION CREDENZA

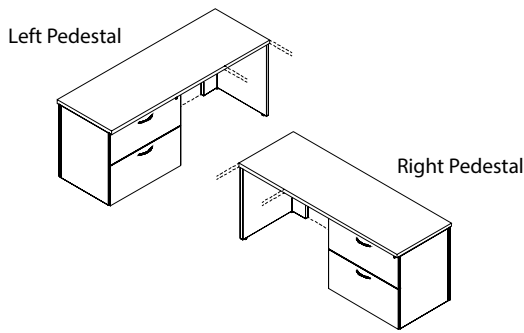

"U" WORKSTATION CREDENZA - LATERAL FILE

STANDARD FEATURES

- Full extension drawers - locking
- Fully finished for open plan
- Full veneer modesty
- 1 Standard grommet - matches pull finish or specify black TM30 or silver TM31

NOTES

- Keyboard not available on 60", 66", 70" units.

[CLICK HERE TO VIEW PRODUCT INDEX](#)

1 SELECT A STYLE

DIMENSIONS		STYLE NUMBER	LIST PRICE	STYLE NUMBER	LIST PRICE	STYLE NUMBER	LIST PRICE
W" x D" x H"	WGT	"W" Veneer Top Veneer Chassis		"G" High Pressure Laminate Top Veneer Chassis		"M" Thermally Fused Laminate Top Thermally Fused Laminate Chassis	
<b>Left Pedestal</b>							
96 x 24 x 29	280	CRP9624CA940W	3155	CRP9624CA940G	3155	"M" Option N/A	
84 x 24 x 29	260	CRP8424CA940W	2953	CRP8424CA940G	2953	"M" Option N/A	
72 x 24 x 29	255	CRP7224CA940W	2674	CRP7224CA940G	2674	"M" Option N/A	
66 x 24 x 29	220	CRP6624CA940W	2635	CRP6624CA940G	2635	"M" Option N/A	
60 x 24 x 29	200	CRP6024CA940W	2622	CRP6024CA940G	2622	"M" Option N/A	
<b>Right Pedestal</b>							
96 x 24 x 29	280	CRP9624CA941W	3155	CRP9624CA941G	3155	"M" Option N/A	
84 x 24 x 29	260	CRP8424CA941W	2953	CRP8424CA941G	2953	"M" Option N/A	
72 x 24 x 29	255	CRP7224CA941W	2674	CRP7224CA941G	2674	"M" Option N/A	
66 x 24 x 29	220	CRP6624CA941W	2635	CRP6624CA941G	2635	"M" Option N/A	
60 x 24 x 29	200	CRP6024CA941W	2622	CRP6024CA941G	2622	"M" Option N/A	

2 SELECT A FINISH

"W" Veneer	"G" HPL	"M" TFL	Finish
WAC	GAC	-	Amber Cherry
WRC	-	-	Caramel Cherry
WIC	GIC	-	Crimson Cherry
WEC	-	-	Ebony Cherry
WHC	GHC	-	Honey Cherry
WOC	GOC	-	KoKo Cherry
WSC	-	-	Scotch Cherry
WCM	GCM	-	Clear Maple
WWM	GWM	-	Wheat Maple
WEW	GEW	-	Executive Walnut
WRW	-	-	Gray Luster Walnut
WGW	-	-	Gunstock Walnut
WJW	-	-	Judicial Walnut
WNW	GNW	-	Natural Walnut
WTW	GTW	-	Studio Teak Walnut
WWP	GWL	-	Designer White

3 SELECT AN EDGE



5 OPTIONS

ACCESSORIES

- K28: Articulating Keyboard w/ Mouse - \$375
- K18: CPU Retractable Cradle - \$195

DRAWERS

- P33: Wood Drawer Upgrade - \$40 per drawer
- P40W: extra Box/Box/File or File/File to Kneespace - \$875 (N/A on 60" W)

GROMMETS (STANDARD LOCATION)

- Specify Color - \$45 ea.
- Black: TM30-C (Center)
- Silver: TM31-C (Center)

GROMMETS (NON-STANDARD LOCATION)

- Provide drawing w/ Grommet Location and Specify Color - \$90 ea.
- Black: TM30-NS
- Silver: TM31-NS

MODESTY

- M34T: "W" "G" Style Drop Door Tech Modesty - \$125
- M51: Open Back Modesty with Wire Mgmt Rail - Deduct \$95

4 SELECT HARDWARE

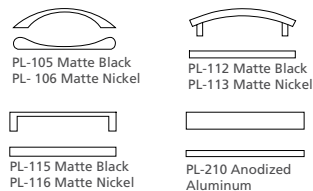

Box/Box/File



File/File

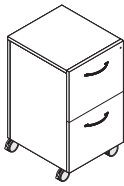

Box/File



**OPEN PLAN MOBILE PEDESTAL**

**STANDARD FEATURES**

- Finished all sides and top
- Full extension drawers - locking
- Soft close suspension drawer(s)

**NOTES**

- Pedestal Cushion can be specified on all pedestals, but on Box/ Box/ File and File/File unit will not fit under work surface w/ cushion.

[CLICK HERE TO VIEW PRODUCT INDEX](#)

**1 SELECT A STYLE**

DIMENSIONS		STYLE NUMBER	LIST PRICE	STYLE NUMBER	LIST PRICE	STYLE NUMBER	LIST PRICE
W" x D" x H"	WGT	"W" Veneer Top Veneer Chassis		"G" High Pressure Laminate Top Veneer Chassis		"M" Thermally Fused Laminate Top Thermally Fused Laminate Chassis	
<b>Box/Box/File</b>							
16 x 18 x 27	70	CRP1618PD424W	1040	"G" option N/A		"M" Option N/A	
<b>File/File</b>							
16 x 18 x 27	70	CRP1618PD425W	1040	"G" option N/A		"M" Option N/A	
<b>Box/File</b>							
16 x 18 x 23	55	CRP1618PD423W	960	"G" Option N/A		"M" Option N/A	

**STL-424 Cushion (Choose Grade Below)**

COM	COL	1	2	3	4	5	6	7	8	9	10	11/ L1	12	13/ L2
190	210	235	250	265	280	295	310	325	340	355	370	385	400	430

**2 SELECT A FINISH**

"W" Veneer	"G" HPL	"M" TFL	
WAC	GAC	-	Amber Cherry
WRC	-	-	Caramel Cherry
WIC	GIC	-	Crimson Cherry
WEC	-	-	Ebony Cherry
WHC	GHC	-	Honey Cherry
WOC	GOC	-	KoKo Cherry
WSC	-	-	Scotch Cherry
WCM	GCM	-	Clear Maple
WWM	GWM	-	Wheat Maple
WEW	GEW	-	Executive Walnut
WRW	-	-	Gray Luster Walnut
WGW	-	-	Gunstock Walnut
WJW	-	-	Judicial Walnut
WNW	GNW	-	Natural Walnut
WTW	GTW	-	Studio Teak Walnut
WWP	GWL	-	Designer White

**3 SELECT AN EDGE**

Edge Profile  
Option Not Available

**5 OPTIONS**

- CUSHION**  
- STL-424: Cushion option for Box/File unit - .75 yd required
- DRAWER**  
- P33: Wood Drawer Upgrade - \$40 per drawer

**4 SELECT HARDWARE**

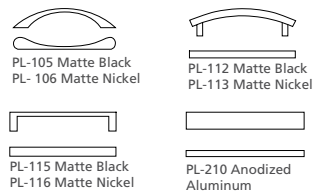

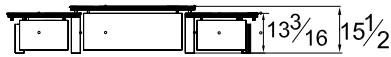
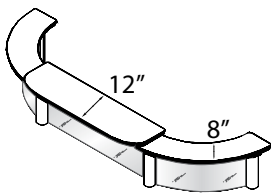

**CURVED DESK 12"/8" COUNTER**

**STANDARD FEATURES**

- 3" Silver counter posts standard
- Countertop 1-5/16" veneer (Knife edge profile)
- Frosted acrylic privacy screen w/ metal rods & caps

- "U" & "V" Counter Assemblies Cannot Be Mixed.
- Veneer Countertops Can Be Specified In Different Veneer & Finish From Chassis

**NOTES**

- 4" Overhang To Front
- (4) posts
- Decorative Acrylic Privacy Screen - Contact Customer Service For Quote.

[CLICK HERE TO VIEW PRODUCT INDEX](#)

**1 SELECT A STYLE**

DIMENSIONS		STYLE NUMBER	LIST PRICE	STYLE NUMBER	LIST PRICE	STYLE NUMBER	LIST PRICE
W" x D" x H"	WGT	"W" Veneer Veneer Top Veneer Chassis		"G" HPL High Pressure Laminate Top Veneer Chassis		"M" TFL Thermally Fused Laminate Top Thermally Fused Laminate Chassis	
<b>For Desk Sizes 24"D :</b>							
96 x 24 x 15.5	65	CRP9624TC224W	3431	CRP9624TC224G	3431	"M" Option N/A	
90 x 24 x 15.5	60	CRP9024TC224W	3236	CRP9024TC224G	3236	"M" Option N/A	
84 x 24 x 15.5	60	CRP8424TC224W	3032	CRP8424TC224G	3032	"M" Option N/A	
78 x 24 x 15.5	55	CRP7824TC224W	2911	CRP7824TC224G	2911	"M" Option N/A	
72 x 24 x 15.5	55	CRP7224TC224W	2847	CRP7224TC224G	2847	"M" Option N/A	
<b>For Desk Sizes 30"D :</b>							
96 x 30 x 15.5	70	CRP9630TC224W	3485	CRP9630TC224G	3485	"M" Option N/A	
90 x 30 x 15.5	65	CRP9030TC224W	3290	CRP9030TC224G	3290	"M" Option N/A	
84 x 30 x 15.5	65	CRP8430TC224W	3086	CRP8430TC224G	3086	"M" Option N/A	
78 x 30 x 15.5	60	CRP7830TC224W	2964	CRP7830TC224G	2964	"M" Option N/A	
72 x 30 x 15.5	60	CRP7230TC224W	2901	CRP7230TC224G	2901	"M" Option N/A	

**2 SELECT A FINISH**

"W" Veneer	"G" HPL	"M" TFL	
WAC	GAC	-	Amber Cherry
WRC	-	-	Caramel Cherry
WIC	GIC	-	Crimson Cherry
WEC	-	-	Ebony Cherry
WHC	GHC	-	Honey Cherry
WOC	GOC	-	KoKo Cherry
WSC	-	-	Scotch Cherry
WCM	GCM	-	Clear Maple
WWM	GWM	-	Wheat Maple
WEW	GEW	-	Executive Walnut
WRW	-	-	Gray Luster Walnut
WGW	-	-	Gunstock Walnut
WJW	-	-	Judicial Walnut
WNW	GNW	-	Natural Walnut
WTW	GTW	-	Studio Teak Walnut
WWP	GWL	-	Designer White

**3 SELECT AN EDGE**



**5 OPTIONS**

- SOLID SURFACE TOP - FOR DESK SIZES 24" D (FLAT EDGE ONLY)**
- Solid Surface: Black Pearl G10, Sea Oat Quartz G38, White Quartz G4
  - SS9624: For desk size 96 x 24 - \$2225
  - SS9024: for desk size 90 x 24 - \$1950
  - SS8424: For desk size 84 x 24 - \$1875
  - SS7824: For desk size 78 x 24 - \$1875
  - SS7224: For desk size 72 x 24 - \$1755
- SOLID SURFACE TOP - FOR DESK SIZES 30" D (FLAT EDGE ONLY)**
- Solid Surface: Black Pearl G10, Sea Oat Quartz G38, White Quartz G4
  - SS9630: For desk size 96 x 30 - \$2455
  - SS9030: For desk size 90 x 30 - \$2185
  - SS8430: For desk size 84 x 30 - \$2105
  - SS7830: For desk size 78 x 30 - \$2105
  - SS7230: For desk size 72 x 30 - \$1990

**4 SELECT HARDWARE**

Hardware Option Not Available

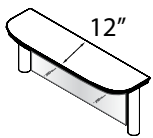

**DESK 12" HALF COUNTER**

**STANDARD FEATURES**

- 3" Silver counter posts standard
- Countertop 1-5/16" veneer (Knife edge profile)
- Frosted acrylic privacy screen w/ metal rods & caps

- Desk half counter can only be used as a freestanding unit
- Veneer Countertops Can Be Specified In Different Veneer & Finish From Chassis

**NOTES**

- 4" Overhang To Front
- (2) posts
- Decorative Acrylic Privacy Screen - Contact Customer Service For Quote.

[CLICK HERE TO VIEW PRODUCT INDEX](#)

**1 SELECT A STYLE**

DIMENSIONS		STYLE NUMBER	LIST PRICE	STYLE NUMBER	LIST PRICE	STYLE NUMBER	LIST PRICE
W" x D" x H"	WGT	"W" Veneer Veneer Top Veneer Chassis		"G" HPL High Pressure Laminate Top Veneer Chassis		"M" TFL Thermally Fused Laminate Top Thermally Fused Laminate Chassis	
53 x 12 x 16	35	CRP5312TC504W	1868	CRP5312TC504G	1868	"M" Option N/A	
47 x 12 x 16	30	CRP4712TC504W	1679	CRP4712TC504G	1679	"M" Option N/A	
41 x 12 x 16	30	CRP4112TC504W	1592	CRP4112TC504G	1592	"M" Option N/A	
35 x 12 x 16	25	CRP3512TC504W	1504	CRP3512TC504G	1504	"M" Option N/A	
29 x 12 x 16	25	CRP2912TC504W	1445	CRP2912TC504G	1445	"M" Option N/A	
23 x 12 x 16	20	CRP2312TC504W	1382	CRP2312TC504G	1382	"M" Option N/A	

**2 SELECT A FINISH**

"W" Veneer	"G" HPL	"M" TFL	
WAC	GAC	-	Amber Cherry
WRC	-	-	Caramel Cherry
WIC	GIC	-	Crimson Cherry
WEC	-	-	Ebony Cherry
WHC	GHC	-	Honey Cherry
WOC	GOC	-	KoKo Cherry
WSC	-	-	Scotch Cherry
WCM	GCM	-	Clear Maple
WWM	GWM	-	Wheat Maple
WEW	GEW	-	Executive Walnut
WRW	-	-	Gray Luster Walnut
WGW	-	-	Gunstock Walnut
WJW	-	-	Judicial Walnut
WNW	GNW	-	Natural Walnut
WTW	GTW	-	Studio Teak Walnut
WWP	GWL	-	Designer White

**3 SELECT AN EDGE**

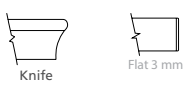

**5 OPTIONS**

- SOLID SURFACE TOP (FLAT EDGE ONLY)**
- Solid Surface: Black Pearl G10, Sea Oat Quartz G38, White Quartz G4
  - S55312: For counter size 53 x 12 - \$975
  - S54712: For counter size 47 x 12 - \$700
  - S54112: For counter size 41 x 12 - \$625
  - S53512: For counter size 35 x 12 - \$625
  - S52912: For counter size 29 x 12 - \$510
  - S52312: For counter size 23 x 12 - \$375

**4 SELECT HARDWARE**

Hardware Option Not Available



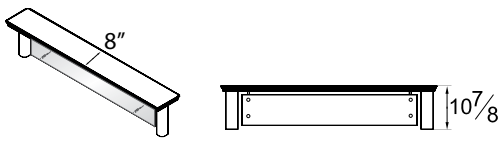

**"L" RETURN 8" COUNTER**

**STANDARD FEATURES**

- 3" Silver counter posts standard
- Countertop 1-5/16" veneer (Knife edge profile)
- Frosted acrylic privacy screen w/ metal rods & caps

Customer Service For Quote.

- "L" Return counter can only be used with TC464 and TC465 SKUs
- Veneer Countertops Can Be Specified In Different Veneer & Finish From Chassis

**NOTES**

- 8" Counter Is Flush To Outside Edge of Return
- (3) posts for 72"-60" W counters, (2) posts for 54"-36" W counters
- Decorative Acrylic Privacy Screen - Contact

[CLICK HERE TO VIEW PRODUCT INDEX](#)

**1 SELECT A STYLE**

DIMENSIONS		STYLE NUMBER	LIST PRICE	STYLE NUMBER	LIST PRICE	STYLE NUMBER	LIST PRICE
W" x D" x H"	WGT	"W" Veneer Veneer Top Veneer Chassis		"G" HPL High Pressure Laminate Top Veneer Chassis		"M" TFL Thermally Fused Laminate Top Thermally Fused Laminate Chassis	
<b>Left Return</b>							
72 x 8 x 10	40	CRP7208TC464W	2292	CRP7208TC464G	2292	"M" Option N/A	
66 x 8 x 10	35	CRP6608TC464W	2171	CRP6608TC464G	2171	"M" Option N/A	
60 x 8 x 10	35	CRP6008TC464W	1927	CRP6008TC464G	1927	"M" Option N/A	
54 x 8 x 10	30	CRP5408TC464W	1748	CRP5408TC464G	1748	"M" Option N/A	
48 x 8 x 10	30	CRP4808TC464W	1557	CRP4808TC464G	1557	"M" Option N/A	
42 x 8 x 10	25	CRP4208TC464W	1436	CRP4208TC464G	1436	"M" Option N/A	
36 x 8 x 10	25	CRP3608TC464W	1304	CRP3608TC464G	1304	"M" Option N/A	
<b>Right Return</b>							
72 x 8 x 10	40	CRP7208TC465W	2292	CRP7208TC465G	2292	"M" Option N/A	
66 x 8 x 10	35	CRP6608TC465W	2171	CRP6608TC465G	2171	"M" Option N/A	
60 x 8 x 10	35	CRP6008TC465W	1927	CRP6008TC465G	1927	"M" Option N/A	
54 x 8 x 10	30	CRP5408TC465W	1748	CRP5408TC465G	1748	"M" Option N/A	
48 x 8 x 10	30	CRP4808TC465W	1557	CRP4808TC465G	1557	"M" Option N/A	
42 x 8 x 10	25	CRP4208TC465W	1436	CRP4208TC465G	1436	"M" Option N/A	
36 x 8 x 10	25	CRP3608TC465W	1304	CRP3608TC465G	1304	"M" Option N/A	

**2 SELECT A FINISH**      **3 SELECT AN EDGE**      **5 OPTIONS**

"W" Veneer	"G" HPL	"M" TFL	
WAC	GAC	-	Amber Cherry
WRC	-	-	Caramel Cherry
WIC	GIC	-	Crimson Cherry
WEC	-	-	Ebony Cherry
WHC	GHC	-	Honey Cherry
WOC	GOC	-	KoKo Cherry
WSC	-	-	Scotch Cherry
WCM	GCM	-	Clear Maple
WWM	GWM	-	Wheat Maple
WEW	GEW	-	Executive Walnut
WRW	-	-	Gray Luster Walnut
WGW	-	-	Gunstock Walnut
WJW	-	-	Judicial Walnut
WNW	GNW	-	Natural Walnut
WTW	GTW	-	Studio Teak Walnut
WWP	GWL	-	Designer White



**SOLID SURFACE TOP (FLAT EDGE ONLY)**

- Solid Surface: Black Pearl G10, Sea Oat Quartz G38, White Quartz G4
- SS7208: For return size 72 x 08 - \$4975
- SS6608: For return size 66 x 08 - \$975
- SS6008: For return size 60 x 08 - \$840
- SS5408: For return size 54 x 08 - \$700
- SS4808: For return size 48 x 08 - \$700
- SS4208: For return size 42 x 08 - \$625
- SS3608: For return size 36 x 08 - \$490

**4 SELECT HARDWARE**

Hardware Option Not Available

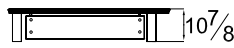
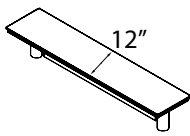

**"V" RETURN 12" COUNTER**

**STANDARD FEATURES**

- 3" Silver counter posts standard
- Countertop 1-5/16" veneer (Knife edge profile)
- Frosted acrylic privacy screen w/ metal rods & caps

Mixed.

- Veneer Countertops Can Be Specified In Different Veneer & Finish From Chassis

**NOTES**

- (2 or 3) posts
- Decorative Acrylic Privacy Screen - Contact Customer Service For Quote.
- "U" & "V" Counter Assemblies Cannot Be

[CLICK HERE TO VIEW PRODUCT INDEX](#)

**1 SELECT A STYLE**

DIMENSIONS		STYLE NUMBER	LIST PRICE	STYLE NUMBER	LIST PRICE	STYLE NUMBER	LIST PRICE
W" x D" x H"	WGT	"W" Veneer Veneer Top Veneer Chassis		"G" HPL High Pressure Laminate Top Veneer Chassis		"M" TFL Thermally Fused Laminate Top Thermally Fused Laminate Chassis	
<b>Left Return</b>							
72 x 12 x 10	50	CRP7212TC467W	2414	CRP7212TC467G	2414	"M" Option N/A	
66 x 12 x 10	45	CRP6612TC467W	2292	CRP6612TC467G	2292	"M" Option N/A	
60 x 12 x 10	45	CRP6012TC467W	2048	CRP6012TC467G	2048	"M" Option N/A	
54 x 12 x 10	40	CRP5412TC467W	1868	CRP5412TC467G	1868	"M" Option N/A	
48 x 12 x 10	30	CRP4812TC467W	1679	CRP4812TC467G	1679	"M" Option N/A	
42 x 12 x 10	30	CRP4212TC467W	1557	CRP4212TC467G	1557	"M" Option N/A	
36 x 12 x 10	25	CRP3612TC467W	1436	CRP3612TC467G	1436	"M" Option N/A	
<b>Right Return</b>							
72 x 12 x 10	50	CRP7212TC468W	2414	CRP7212TC468G	2414	"M" Option N/A	
66 x 12 x 10	45	CRP6612TC468W	2292	CRP6612TC468G	2292	"M" Option N/A	
60 x 12 x 10	45	CRP6012TC468W	2048	CRP6012TC468G	2048	"M" Option N/A	
54 x 12 x 10	40	CRP5412TC468W	1868	CRP5412TC468G	1868	"M" Option N/A	
48 x 12 x 10	30	CRP4812TC468W	1679	CRP4812TC468G	1679	"M" Option N/A	
42 x 12 x 10	30	CRP4212TC468W	1557	CRP4212TC468G	1557	"M" Option N/A	
36 x 12 x 10	25	CRP3612TC468W	1436	CRP3612TC468G	1436	"M" Option N/A	

**2 SELECT A FINISH**

"W" Veneer	"G" HPL	"M" TFL	
WAC	GAC	-	Amber Cherry
WRC	-	-	Caramel Cherry
WIC	GIC	-	Crimson Cherry
WEC	-	-	Ebony Cherry
WHC	GHC	-	Honey Cherry
WOC	GOC	-	KoKo Cherry
WSC	-	-	Scotch Cherry
WCM	GCM	-	Clear Maple
WWM	GWM	-	Wheat Maple
WEW	GEW	-	Executive Walnut
WRW	-	-	Gray Luster Walnut
WGW	-	-	Gunstock Walnut
WJW	-	-	Judicial Walnut
WNW	GNW	-	Natural Walnut
WTW	GTW	-	Studio Teak Walnut
WWP	GWL	-	Designer White

**3 SELECT AN EDGE**



**5 OPTIONS**

**SOLID SURFACE TOP**

- Solid Surface: Black Pearl G10, Sea Oat Quartz G38, White Quartz G4
- SS7212: For return size 72 x 12 - \$975
- SS6612: For return size 66 x 12 - \$975
- SS6012: For return size 60 x 12 - \$840
- SS5412: For return size 54 x 12 - \$700
- SS4812: For return size 48 x 12 - \$700
- SS4212: For return size 42 x 12 - \$625
- SS3612: For return size 36 x 12 - \$490

**4 SELECT HARDWARE**

Hardware Option Not Available

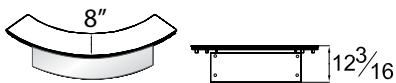

**"V" BRIDGE CORNER COUNTER**

**STANDARD FEATURES**

- Countertop 1-5/16" veneer (Knife edge profile)
- Frosted acrylic privacy screen w/ metal rods & caps

- "V" Bridge corner counter can only be used with TC467 and TC468 SKUs
- Veneer Countertops Can Be Specified In Different Veneer & Finish From Chassis

**NOTES**

- 8" Wide Counter
- Decorative Acrylic Privacy Screen - Contact Customer Service For Quote.
- "U" & "V" Counter Assemblies Cannot Be Mixed.

[CLICK HERE TO VIEW PRODUCT INDEX](#)

**1 SELECT A STYLE**

DIMENSIONS		STYLE NUMBER	LIST PRICE	STYLE NUMBER	LIST PRICE	STYLE NUMBER	LIST PRICE
W" x D" x H"	WGT	<b>"W"</b> Veneer Top Veneer Chassis		<b>"G"</b> High Pressure Laminate Top Veneer Chassis		<b>"M"</b> Thermally Fused Laminate Top Thermally Fused Laminate Chassis	
30 x 30 x 29	15	CRP3030TC471W	779	CRP3030TC471G	779	"M" Option N/A	

**2 SELECT A FINISH**

<b>"W"</b> Veneer	<b>"G"</b> HPL	<b>"M"</b> TFL	
WAC	GAC	-	Amber Cherry
WRC	-	-	Caramel Cherry
WIC	GIC	-	Crimson Cherry
WEC	-	-	Ebony Cherry
WHC	GHC	-	Honey Cherry
WOC	GOC	-	KoKo Cherry
WSC	-	-	Scotch Cherry
WCM	GCM	-	Clear Maple
WWM	GWM	-	Wheat Maple
WEW	GEW	-	Executive Walnut
WRW	-	-	Gray Luster Walnut
WGW	-	-	Gunstock Walnut
WJW	-	-	Judicial Walnut
WNW	GNW	-	Natural Walnut
WTW	GTW	-	Studio Teak Walnut
WWP	GWL	-	Designer White

**3 SELECT AN EDGE**



**5 OPTIONS**

- SOLID SURFACE TOP (FLAT EDGE ONLY)**
- Solid Surface: Black Pearl G10, Sea Oat Quartz G38, White Quartz G4
  - SS3030: For bridge size 30 x 30 - \$750

**4 SELECT HARDWARE**

Hardware Option Not Available

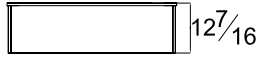
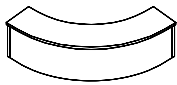

**18" "V" CORNER COUNTER SHELL**

**STANDARD FEATURES**

- 3/4" Curved Wood Back Panel
- Countertop 1-5/16" veneer (Knife edge profile)

**NOTES**

- 3/4" Thick Counter Shell Back Is Suitable For Signage Application
- "U" & "V" Counter Assemblies Cannot Be Mixed.
- Veneer Countertops Can Be Specified In Different Veneer & Finish From Chassis

[CLICK HERE TO VIEW PRODUCT INDEX](#)

**1 SELECT A STYLE**

DIMENSIONS		STYLE NUMBER	LIST PRICE	STYLE NUMBER	LIST PRICE	STYLE NUMBER	LIST PRICE
W" x D" x H"	WGT	<b>"W"</b> Veneer Top Veneer Chassis		<b>"G"</b> High Pressure Laminate Top Veneer Chassis		<b>"M"</b> Thermally Fused Laminate Top Thermally Fused Laminate Chassis	
30 x 30 x 29	60	CRP3030TC472W	984	CRP3030TC472G	984	"M" Option N/A	

**2 SELECT A FINISH**

<b>"W"</b> Veneer	<b>"G"</b> HPL	<b>"M"</b> TFL	
WAC	GAC	-	Amber Cherry
WRC	-	-	Caramel Cherry
WIC	GIC	-	Crimson Cherry
WEC	-	-	Ebony Cherry
WHC	GHC	-	Honey Cherry
WOC	GOC	-	KoKo Cherry
WSC	-	-	Scotch Cherry
WCM	GCM	-	Clear Maple
WWM	GWM	-	Wheat Maple
WEW	GEW	-	Executive Walnut
WRW	-	-	Gray Luster Walnut
WGW	-	-	Gunstock Walnut
WJW	-	-	Judicial Walnut
WNW	GNW	-	Natural Walnut
WTW	GTW	-	Studio Teak Walnut
WWP	GWL	-	Designer White

**3 SELECT AN EDGE**

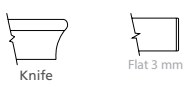

**5 OPTIONS**

**SOLID SURFACE TOP (FLAT EDGE ONLY)**  
 - Solid Surface: Black Pearl G10, Sea Oat Quartz G38, White Quartz G4  
 - S53030: For corner size 30 x 30 - \$750

**4 SELECT HARDWARE**

Hardware  
Option Not  
Available

**BASE MODIFICATIONS**

**RUNOFF SLEIGH BASE**

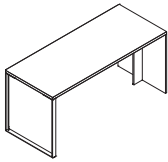

STYLE NUMBER	LIST PRICE	SPECIFICATIONS
<b>24" Metal Sleigh Base</b> SSB24	450	- Metal Sleigh base - standard in silver finish
<b>30" Metal Sleigh Base</b> SSB30	475	
<b>36" Metal Sleigh Base</b> SSB36	495	

Available: - Central, NOT SO square, Spaces

**COMPUTER SUPPORT**

**DELUXE SINGLE MONITOR ARM W/ USB POST**



STYLE NUMBER	LIST PRICE	SPECIFICATIONS
MA1952	495	<ul style="list-style-type: none"> <li>- (4) 2.0 USB Ports</li> <li>- Post Length: 22-1/2"H, Post Base Requires 80mm Dia. Hole</li> <li>- Spring Assist - Full Movement Arm, Arm Extends Up To 13 - 3/8"</li> <li>- Supports Screens Up To 24", Swivels 180 degrees - Mount Plate Tilts 85 degrees</li> <li>- Arm: Die Cast Aluminum</li> </ul> <p><b>Notes</b></p> <ul style="list-style-type: none"> <li>- Surface Factory Bored / Ready To Install</li> </ul>

Available: - All DARRAN Collections

**COMPUTER SUPPORT**

**DELUXE DOUBLE MONITOR ARM W/ USB POST**



STYLE NUMBER	LIST PRICE	SPECIFICATIONS
MA2952	795	<ul style="list-style-type: none"> <li>- (4) 2.0 USB Ports</li> <li>- Post Length: 22-1/2"H, Post Base Requires 80mm Dia. Hole</li> <li>- Spring Assist - Full Movement Arm, Arm Extends Up To 13 - 3/8"</li> <li>- Supports Screens Up To 24", Swivels 180 degrees - Mount Plate Tilts 85 degrees</li> <li>- Arm: Die Cast Aluminum</li> </ul> <p><b>Notes</b></p> <ul style="list-style-type: none"> <li>- Surface Factory Bored / Ready To Install</li> <li>- Can Accommodate Up To 4 Monitors By Ordering Extra Double Arms.</li> <li>1 Extra Arm and 1 Double Clamp - Add\$305</li> </ul>

Available: - All DARRAN Collections

**COMPUTER SUPPORT**

**CPU RETRACTABLE CRADLE**

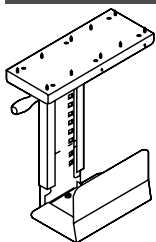

STYLE NUMBER	LIST PRICE	SPECIFICATIONS
K18	195	<ul style="list-style-type: none"> <li>- Black Metal CPU Carriage</li> <li>- Full 360° swivel capability allows easy access to rear of CPU for cables / wires</li> <li>- Track allows 8- 1/2" extension</li> <li>- Width Adjustment 5-1/2" to 9-1/4"</li> <li>- Height adjustment 14- 5/8" to 20- 1/2"</li> <li>- Black epoxy finish</li> </ul> <p><b>Notes</b></p> <ul style="list-style-type: none"> <li>- Factory Installed</li> </ul>

Available: - All DARRAN Collections

COMPUTER SUPPORT

ARTICULATING KEYBOARD TRAY

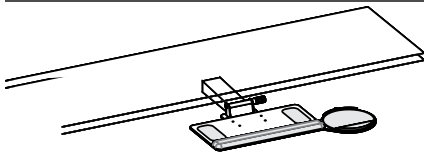

STYLE NUMBER

*Factory Installed*

K28

*Field Installed*

K28F

LIST PRICE

375

395

SPECIFICATIONS

- Adjusts effortlessly - A simple one-handed motion allows the keyboard to be repositioned instantly, without the use of locks or levers
- Encourages low-risk postures - Maximizes adjustability within a safe operating range.
- Will last a lifetime - Exceeds all applicable BIFMA Standards and comes with a lifetime guarantee.

Notes

- Factory Installed (standard)
- FIELD INSTALL - \$395

Available: - All DARRAN Collections

COMPUTER SUPPORT

TRADITIONAL PULL-OUT DRAWER WITH KEYBOARD TRAY

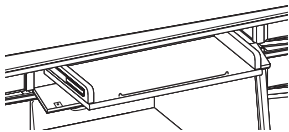

STYLE NUMBER

K21

LIST PRICE

450

SPECIFICATIONS

- Traditional Pull-out Drawer w/Keyboard Tray

Available: - Jamestown

CONFERENCE DESK SUPPORT POST OPTIONS

WOOD DRUM



STYLE NUMBER

*6" Diameter Drum*

B6

LIST PRICE

395

SPECIFICATIONS

- Available in Walnut / Cherry / Maple
- Adjustable levelers
- Replaces standard metal round legs

Notes

- Specify Finish

Available: - Central Park, NOT SO square

CONFERENCE DESK SUPPORT POST OPTIONS

WOOD HALF DRUM

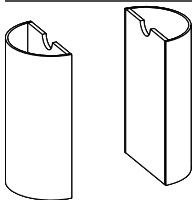

STYLE NUMBER

*8" Half Drum*

HC08

*16" Diameter Drum*

HC16

LIST PRICE

695

895

SPECIFICATIONS

- Available in Walnut / Cherry / Maple
- Adjustable levelers

Notes

- Specify Finish

Available: - Central Park, NOT SO square, Richmond Park

CONFERENCE DESK SUPPORT POST OPTIONS

METAL OVAL "T" BASE



STYLE NUMBER

*Silver*

32MOTS

*Black*

32MOTB

LIST PRICE

595

595

SPECIFICATIONS

- 3" x 1" Aluminum square extrusion
- Leveler adjustment
- Oval Post

Available: - Silver or Black

DOOR MODIFICATIONS

SOFT CLOSE DOOR HINGE



STYLE NUMBER

D9SC

LIST PRICE

15 Per Door

SPECIFICATIONS

- Snap onto standard door hinge
- Requires (1) per door
- Max door height 43"
- Factory installed where specified
- Individually shipped for field installation

Notes

- Specify Each Item To Have Slow Close Feature

Available: - All DARRAN Collections

DOOR MODIFICATIONS

DELETE DOORS

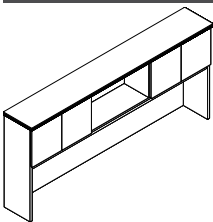

STYLE NUMBER

D6

LIST PRICE

N/C

SPECIFICATIONS

- Standard Door overheads and cabinets can have door deleted for open access. Modification of hinge rails and structural components are made face ready.

Available: - All DARRAN Collections

DOOR MODIFICATIONS

- REPLACE GLASS PANEL INSERT WITH VENEER PANEL INSERT



Glass Door

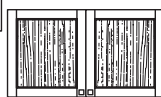

Wood Door

STYLE NUMBER

D35

LIST PRICE

30 per door

SPECIFICATIONS

- Replace glass panel insert with veneer panel insert

Notes

- Not Available on "M" skus
- Glass door has beveled glass
- Wood door w/ veneer insert - only available on "W" style

Available: - Capitol Park, Jamestown, Prado, Richmond Park

**DOOR MODIFICATIONS** **DELETE DOORS/REPLACE BLACK LAMINATE SHELF W/ FINISHED SHELF**

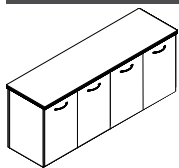

**STYLE NUMBER**  
D6A

**LIST PRICE**  
N/C

**SPECIFICATIONS**  
- Delete doors and replace black laminate shelf with finished shelf

Available: - All Storage Credenzas ("W"/"G" Styles ).  
Excludes Rail.

**DOOR MODIFICATIONS** **PANEL DOOR LOCK**

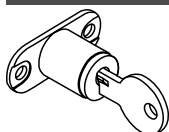

**STYLE NUMBER**  
D2

**LIST PRICE**  
95 Per Door Set

**SPECIFICATIONS**  
- Door Locks - 1 Door w/ Lock, Other Door w/ Catch Latch  
- Contact Customer Service regarding limited lock locations and keying.

Available: - Panel Doors, Wood Frame Doors, and Silverluma doors

**DOOR MODIFICATIONS** **GLASS DOOR LOCK**

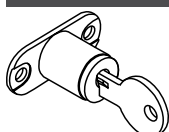

**STYLE NUMBER**  
D2-G

**LIST PRICE**  
195 Per Door Set

**SPECIFICATIONS**  
- Door Locks - 1 Door w/ Lock, Other Door w/ Catch Latch  
- Contact Customer Service regarding limited lock locations and keying.

Available: - Glass Doors

**DOOR MODIFICATIONS** **BOX DRAWER ACCESSORIES**

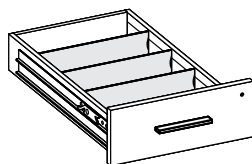

**STYLE NUMBER**  
*Wood Drawer Dividers w/ Clips*  
K-DIV  
*Single Tray - Utility Tray*  
K-Sut

**LIST PRICE**  
SET OF 3 - 30  
  
30 each

**SPECIFICATIONS**  
- K-DIV Extra Wood Drawer Dividers with Clips, Top Box drawers standard with 1 divider  
- K-SUT Single Tray - Utility Tray, Specify Legal or Letter drawer width

Available: - All DARRAN Collections. Excludes Rail.



**DRAWER OPTIONS**

**TRADITIONAL CENTER DRAWER**

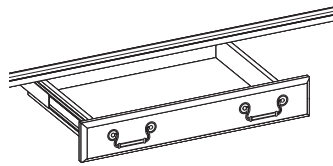

**STYLE NUMBER**  
K17  
*Add Skirt Option*  
K17-SK

**LIST PRICE**  
225  
  
325

**SPECIFICATIONS**  
- Standard on desks in Jamestown Collection. Optional center drawers available for bullet conference desk, kneespace credenzas and corner units. 3 ply hardwood drawer / dowel construction profile shaped drawer front. Specify pull choice.

Available: - Jamestown

**DRAWER OPTIONS**

**FINISHED TRADITIONAL CENTER DRAWER**

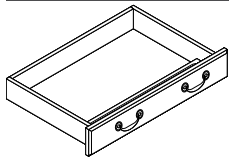

**STYLE NUMBER**  
K30  
*Add Skirt Option*  
K30-SK

**LIST PRICE**  
195  
  
295

**SPECIFICATIONS**  
- Veneer drawer front finished to match unit veneer. Edges are scalloped to match standard drawers.  
- Standard with matching wood grain pencil tray  
- Pulls selected to match unit installed

Available: - Richmond Park

**DRAWER OPTIONS**

**FINISHED CENTER DRAWER**

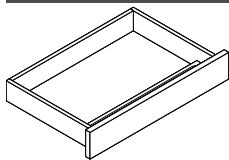

**STYLE NUMBER**  
K31  
*Add Skirt Option*  
K31-SK

**LIST PRICE**  
195  
  
295

**SPECIFICATIONS**  
- Veneer drawer front finished to match unit W or G style veneer.  
- Ball bearing smooth operation  
- Drawer has lifetime guarantee  
- Standard with matching wood grain pencil tray  
- Laminate drawer front to match laminate unit (M style)

Available: - Central Park, NOT SO square, Rail

**DRAWER OPTIONS**

**PRADO/SPACES CENTER DRAWER - VENEER BOTTOM**

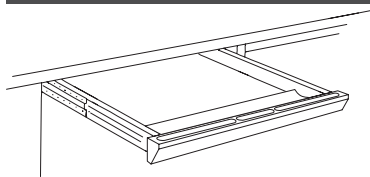

**STYLE NUMBER**  
*Factory Installed*  
K1  
*Field Installed*  
K1BVF

**LIST PRICE**  
275  
  
275

**SPECIFICATIONS**  
- Solid hardwood front beveled and rounded with recessed pencil tray.

Available: - Prado, Spaces

**DRAWER OPTIONS**

**CENTER DRAWER**

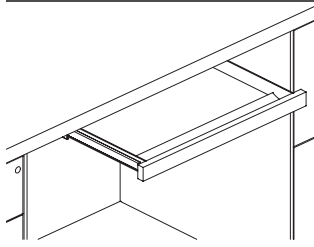

**STYLE NUMBER**

**LIST PRICE**

**SPECIFICATIONS**

*Factory Installed*

- Center Drawer - Factory Installed, Center Drawer - Field Installed

K1R

275

*Field Installed*

K1RF

275

Available: - Rift

**DRAWER OPTIONS**

**CENTER DRAWER WITH SKIRT**

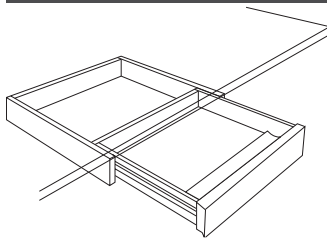

**STYLE NUMBER**

**LIST PRICE**

**SPECIFICATIONS**

*Factory Installed*

- Center Drawer - Factory Installed, Center Drawer - Field Installed

K2R

375

*Field Installed*

K2RF

375

*Add Skirt Option*

K2R-SK

475

Available: - Rift

**DRAWER OPTIONS - BOTTOM COVER**

**BLACK DURA-LEATHER DRAWER BOTTOM COVERS**

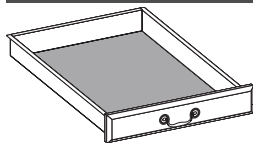

**STYLE NUMBER**

**LIST PRICE**

**SPECIFICATIONS**

P2

75

- Center drawer and Box/Tray drawers are covered in Black Duraleather that adds a prestigious touch.

Available: - Jamestown

**DRAWER OPTIONS - BOTTOM COVER**

**FELT BOTTOM CENTER DRAWER INSERT LINER**



**STYLE NUMBER**

**LIST PRICE**

**SPECIFICATIONS**

K3

95

- Inserts into center drawer and features divider for open pen and pencil storage. Removable for easy cleaning.  
- Adds a luxurious touch to center drawers.  
- Color: Dark Brown Coal

Available: - All DARRAN Collections. Excludes Rail.

**DRAWER OPTIONS - UPGRADE**

**WOOD DRAWER UPGRADE**

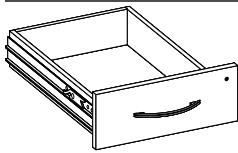

**STYLE NUMBER**  
P33

**LIST PRICE**  
40 Per Drawer

**SPECIFICATIONS**

- Dowel joint construction
- Hardwood veneer multi-ply drawer
- UV finish
- 1/4" Wood veneer bottoms
- File drawer bottoms are fiv block reinforced for heavy weight capacity
- Lifetime guaranteed

Available: - Central Park, Capitol Park, NOT SO square, Rail, Richmond Park

**LIGHTING**

**LT-LED TASK LIGHT**

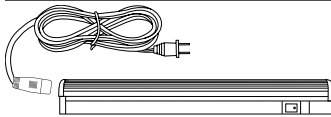

**STYLE NUMBER**  
*24" Tasklight*  
LT-LED24  
*48" Tasklight*  
LT-LED48  
*60" Tasklight*  
LT-LED60  
*Linking Cable*  
LC22

**LIST PRICE**  
90  
165  
180  
20

**SPECIFICATIONS**

- Anodized aluminum finish
- Tilting beam allows adjustability
- Switch with dimming control
- 50,000 hour life
- 12V power drive standard with each task light 30 watt max

**Notes**  
- LC22: 20" LT-LED Task light linking cable

Available: - All DARRAN Collections

**LIGHTING**

**DELETE TASK LIGHT CONCEALMENT APRON RAIL**

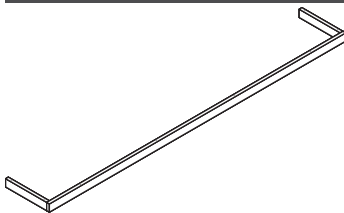

**STYLE NUMBER**  
WAR-D

**LIST PRICE**  
Deduct 125

**SPECIFICATIONS**  
- Delete Tasklight Concealment apron rail when a task light is not used on a wall hung unit

Available: - Wall Hung Units

**LIGHTING**

**SLIM LINE ALUMINUM LED TASK LIGHT**

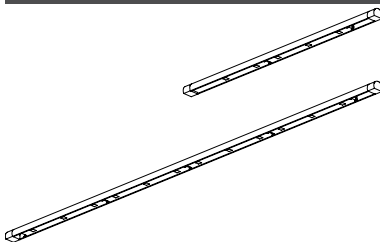

**STYLE NUMBER**  
*24" Tasklight*  
LED24  
*48" Tasklight*  
LED48  
*60" Tasklight*  
LED60  
*Linking Package*  
DPC

**LIST PRICE**  
315  
445  
555  
Deduct 85 per task light

**SPECIFICATIONS**

- Anodized aluminum finish
- Tilting beam allows adjustability
- Switch with dimming control
- 50,000 hour life
- 12V power drive standard with each task light 30 watt max

**Notes**  
- Link multiple tasklights up to 30W of power wattage. Deletes 1 power drive

Available: - Rift and Spaces

**LIGHTING**

**LED INTERIOR CABINET PUCK LIGHT**

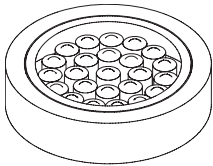

**STYLE NUMBER**

**LIST PRICE**

**SPECIFICATIONS**

*Starter Kit*

295

- Starter kit includes Infeed, 1 Puck Interior Light and the ability to daisy chain up to 6 total Puck Lights

LEDPK

*1 LED Interior Puck Light*

125

- (1) LED Puck Light with 30W power drive and switch  
 - Recessed fixture  
 - 12V linking cord 98"L  
 - Silver finish  
 - 50,000 hour life  
 - 2 watt per light

**Notes**

- Power drive included, Light only

Available: - Overhead/Tower Units with glass doors or no doors

**PEDESTAL MODIFICATIONS**

**BREAKFRONT PEDESTAL WITH WIRE MANAGEMENT CAVITY DOOR**

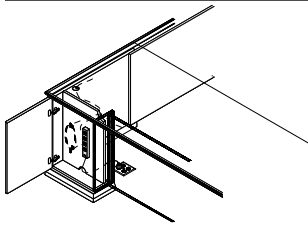

**STYLE NUMBER**

**LIST PRICE**

**SPECIFICATIONS**

PC10

95

- Hinged pedestal front door offers easy access for wire management

*Power Supply Cordset*

PD717

95

- Wire hooks provide wire coil storage  
 - Wire access openings allow access to floor, cabinets interior and kneespace  
 - Cabinet interior is black finish  
 - Top grommet is positioned over cavity for access ease  
 - (Power Strip Optional)

**Notes**

- Breakfront Chassis Only

Available: - All DARRAN Collections. Excludes Jamestown, Rail, Richmond, and Rift.

**PEDESTAL MODIFICATIONS**

**BLACK LAMINATE PRINTER PULLOUT BOTTOM SHELF**

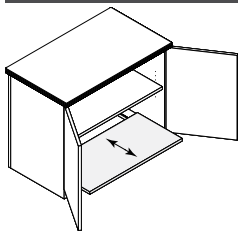

**STYLE NUMBER**

**LIST PRICE**

**SPECIFICATIONS**

PPOS

214

- Black Laminate pullout shelf on suspension  
 - Black grommet  
 - Adjustable Shelf

Available: - All DARRAN Collections. Excludes Rail.

**PEDESTAL MODIFICATIONS**

**ADD VENEER KNEESPACE CABINETS - BASE**

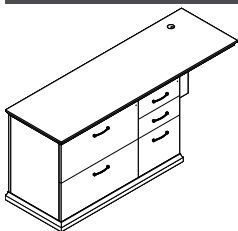

**STYLE NUMBER**

**LIST PRICE**

**SPECIFICATIONS**

*Add Box/Box/File or File/File*

985

- Multi-file specify Box/Box Left or Right

P40B

*Add Lateral File 29" W*

1205

**Notes**

- Add additional Standard Cabinets To Kneespace Area.

P41B

*Add Multi-File - 31"W*

1205

P42B

*Add Storage With Doors 29"W*

1095

P43B

*Add CPU /Printer Cabinet - Open*

1095

P44B

Available: - Capitol Park, Jamestown, Prado, Richmond Park

**PEDESTAL MODIFICATIONS**

**ADD VENEER KNEESPACE CABINETS - NO BASE**

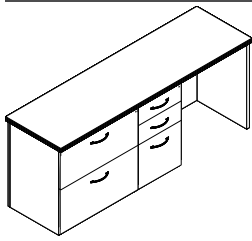

Available: - Central Park, NOT SO square

STYLE NUMBER	LIST PRICE
<i>Add Box/Box/File or File/File</i> P40W	875
<i>Add Lateral File 29" W</i> P41W	985
<i>Add Multi-File - 31"W</i> P42W	1095
<i>Add Storage With Doors 29"W</i> P43W	985
<i>Add CPU /Printer Cabinet - Open</i> P44W	985

**SPECIFICATIONS**  
- Multi-file specify Box/Box Left or Right

**Notes**  
- Add additional Standard Cabinets To Kneespace Area.

**PEDESTAL MODIFICATIONS**

**ADD TECH VENEER KNEESPACE CABINETS - NO BASE**

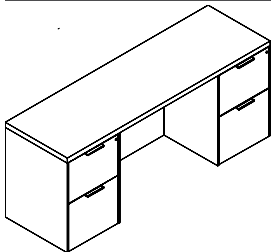

Available: - Rift

STYLE NUMBER	LIST PRICE
<i>Add Box/Box/File or File/File</i> P40T	1100
<i>Add Lateral File 29" W</i> P41T	1210
<i>Add Multi-File - 31"W</i> P42T	1320
<i>Add Storage With Doors 29"W</i> P43T	1210
<i>Add CPU /Printer Cabinet - Open</i> P44T	1210

**SPECIFICATIONS**  
- Multi-file specify Box/Box Left or Right

**Notes**  
- Add additional Standard Cabinets To Kneespace Area.

**PEDESTAL MODIFICATIONS**

**ADD MELAMINE (TFL) KNEESPACE CABINETS - NO BASE**

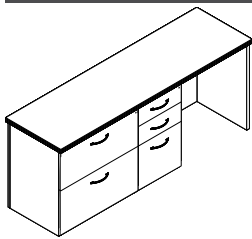

Available: - Central Park (TFL) and NOT SO square (TFL)

STYLE NUMBER	LIST PRICE
<i>Add Box/Box/File or File/File</i> P40M	688
<i>Add Lateral File 29" W</i> P41M	853
<i>Add Multi-File - 31"W</i> P42M	963
<i>Add Storage With Doors 29"W</i> P43M	765
<i>Add CPU /Printer Cabinet - Open</i> P44M	875

**SPECIFICATIONS**  
- Multi-file specify Box/Box Left or Right

**Notes**  
- Add additional Standard Cabinets To Kneespace Area.

**PEDESTAL MODIFICATIONS**

**MODIFY DRAWER CONFIGURATIONS**

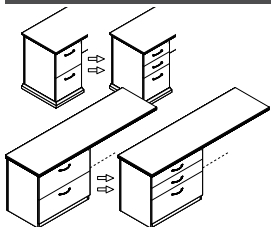

Available: - All DARRAN Collections. Excludes Rail.

STYLE NUMBER	LIST PRICE
<i>File/File to Box/Box/File</i> P6	50 per pedestal
<i>Box/Box/File to File/File</i> P6	50 per pedestal
<i>Lateral File to 2 Box Drawers</i> P8	95 per pedestal

**SPECIFICATIONS**  
- Modify File/File To Box/Box/File - Any Unit

**PEDESTAL MODIFICATIONS**

**MODIFY DRAWER CONFIGURATIONS**

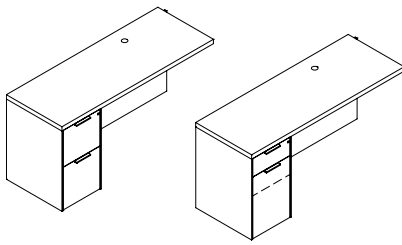

**STYLE NUMBER**

*File/File to Box/Box/File*

P6H

*Lateral File to 2 Box Drawers*

P8

**LIST PRICE**

95 per pedestal

95 per pedestal

**SPECIFICATIONS**

- Modify File/File To Box/Hidden Box/File - Any Unit

Available: - Rift

**POWER / DATA**

**POWER SUPPLY CORDSET**

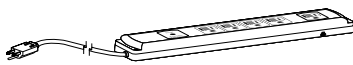

**STYLE NUMBER**

PD717

**LIST PRICE**

95

**SPECIFICATIONS**

- SIZE: 10.75"L x 2.0"W x 1.06"H

- (5) Outlets w/ 10' cord

- Surge suppression (720 Joules)

- 15 Amp breaker

- Available on: Vertical Panels, Cabinet Interiors, and under tops

Available: - All DARRAN Collections

**PRODUCT MODIFICATIONS**

**MODIFY WIDTH - OPEN KNEESPACE**

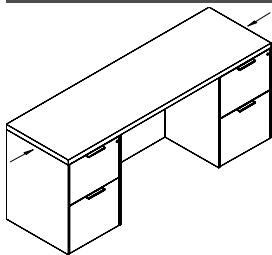

**STYLE NUMBER**

MOD-1

**LIST PRICE**

125

**SPECIFICATIONS**

- Modify width down on any unit with an open kneespace: desk, workstation credenza, bridge, return

Available: - All DARRAN Collections

**PRODUCT MODIFICATIONS**

**MODIFY WIDTH - OPEN/CLOSED STORAGE**

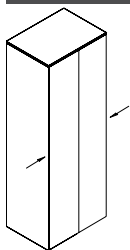

**STYLE NUMBER**

MOD-2

**LIST PRICE**

250

**SPECIFICATIONS**

- Modify width down on any unit with open or closed storage section: overheads, wall hung units, storage credenzas, towers

Available: - All DARRAN Collections

**PRODUCT MODIFICATIONS**

**MODIFY WIDTH - OUTSIDE OF MOD-1, MOD-2**

**STYLE NUMBER**  
MOD-3

**LIST PRICE**  
Contact Factory  
for Pricing

**SPECIFICATIONS**  
- Width modification outside of MOD-1 & MOD-2

Available: - All DARRAN Collections

**PRODUCT MODIFICATIONS**

**MODIFY WIDTH - TACKBOARD, SLAT WALL, VENEER PANEL, OR A GLASSBOARD**

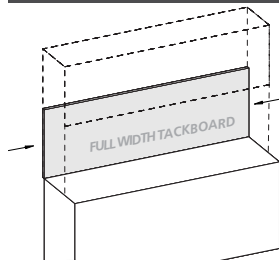

**STYLE NUMBER**  
MOD-4

**LIST PRICE**  
50

**SPECIFICATIONS**  
- Modify width down on tackboard, slat wall, veneer panel, or a overhead glassboard

Available: - All DARRAN Collections

**PRODUCT MODIFICATIONS**

**MODIFY DEPTH - DECREASE DEPTH**

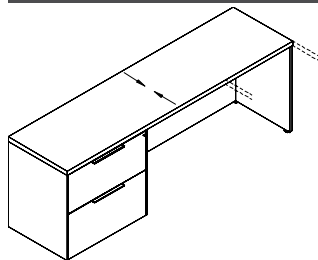

**STYLE NUMBER**  
MOD-5

**LIST PRICE**  
125

**SPECIFICATIONS**  
- Modify depth down (minimum depth for a unit with drawers is 21"D)

**Notes**  
- Ex. 24" to 21", 30" to 24", and 36" to 30"

Available: - All DARRAN Collections

**PRODUCT MODIFICATIONS**

**MODIFY DEPTH - INCREASE DEPTH**

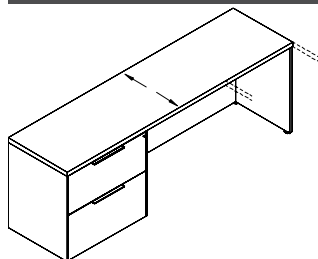

**STYLE NUMBER**  
MOD-6

**LIST PRICE**  
Add 10%

**SPECIFICATIONS**  
- Increase depth  
**Notes**  
- Ex. 24" to 30", 30" to 36", and 36" to 42"

Available: - All DARRAN Collections. Excludes Rift.

**PRODUCT MODIFICATIONS**

**MODIFY HEIGHT**

**STYLE NUMBER**  
MOD-7

**LIST PRICE**  
Contact Factory  
for Pricing

**SPECIFICATIONS**  
- Modify height of a unit

Available: - All DARRAN Collections

**PRODUCT MODIFICATIONS**

**MODIFY CONFERENCE TABLE LENGTH AND WIDTH - 1 PIECE TOP**

**STYLE NUMBER**  
MOD-8

**LIST PRICE**  
125

**SPECIFICATIONS**  
- Modify length/width down on a 1 piece table top

Available: - Conferencing

**PRODUCT MODIFICATIONS**

**MODIFY CONFERENCE TABLE LENGTH AND WIDTH - 2/3 PIECE TOP**

**STYLE NUMBER**  
MOD-9

**LIST PRICE**  
250

**SPECIFICATIONS**  
- Modify length/width down on a 2 or 3 piece table top

Available: - Conferencing

**REFRIGERATOR MODIFICATION**

**REFRIGERATOR CABINET MODIFICATION**

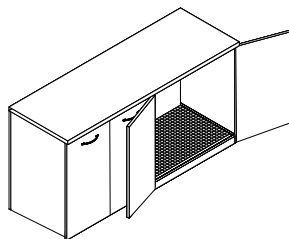

**STYLE NUMBER**  
REF01

**LIST PRICE**  
195

**SPECIFICATIONS**  
- Open back cutout for venting  
- Moisture sponge mat  
- Contaminate ledge  
- Contact customer service for maximum refrigerator size  
(Changes based on unit).

Available: - Storage Credenzas



**SHAPED TOPS** **OVERHEAD/WALL HUNG SHAPED TOP**

STYLE NUMBER	LIST PRICE	SPECIFICATIONS
<b>99"W - 105"W</b>		- Shaped tops for overheads and wall hungs
TOH-1	405	
<b>58"W - 93"W</b>		
TOH-2	315	
<b>29"W - 47"W</b>		
TOH-3	203	

Available: - Central Park, Rail

**SHAPED TOPS** **BOOKCASE SHAPED TOP**

STYLE NUMBER	LIST PRICE	SPECIFICATIONS
<b>29"W - 35"W x 15"D</b>		- 15" D Shaped tops for bookcases
TOH-4	203	- Shaped on front

Available: - Central Park, Rail

**SHAPED TOPS** **TOWER SHAPED TOP**

STYLE NUMBER	LIST PRICE	SPECIFICATIONS
<b>16" Single Width Tower</b>		- 24" deep shaped tops for towers
TOH-5	158	- Shaped on front
<b>29"W - 46"W Tower</b>		
TOH-6	203	

Available: - Central Park, Rail

**SHAPED TOPS** **WORKSURFACE SHAPED TOP**

STYLE NUMBER	LIST PRICE	SPECIFICATIONS
<b>Shape Four Sides</b>		- S4S Applies to desk, bridge or any freestanding unit. This adds shapes or copes to two sides (desk, bridges) or one side and back of units (returns).
S4S	50	
<b>Shape Three Sides</b>		- S3S Applies to credenza units. This adds shapes to the two sides.
S3S	50	- Credenzas are shaped front standard with flat back
		<b>Notes</b>
		- Desk, Freestanding and Credenza units will grow 1" in width due to adding shapes on ends of units.

Available: - Central Park

SHAPED TOPS

PREMIUM EDGE - SHAPED WORKSURFACE TOP

STYLE NUMBER	LIST PRICE	SPECIFICATIONS
<i>Shape Four Sides Premium Edge</i>		
S4S-PE	Add 10%	- S4S-PE Applies to desk, bridge or any freestanding unit. This adds shapes or copes to two sides (desk, bridges) or one side and back with hardwood rims (returns).
<i>Shape Three Sides Premium Edge</i>		
S3S-PE	Add 10%	- S3S-PE Shape Three Sides Premium Edge. Applies to credenza units. This adds shape to the two sides with hardwood rims.
<b>Notes</b>		
- Desk, Freestanding and Credenza units will grow 1" in width due to adding shapes on ends of units.		

\* 10% Upcharge includes 5% for premium edge

Available: - Central Park

SHELF MODIFICATIONS

GLASS SHELVES - TEMPERED FULL WIDTH 26" - 35"

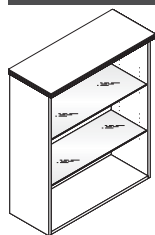

STYLE NUMBER	LIST PRICE	SPECIFICATIONS
<i>26"W - 35"W x 14"D Shelf</i>		
GS14F	85	- Glass Shelves Replace Wood Shelf In Open Or Glass Door Cabinet. Also Order Interior Cabinet Lighting.

Available: - All DARRAN Collections

SHELF MODIFICATIONS

TEMPERED GLASS SHELVES FOR HALF CABINET 17- 1/2" WIDTHS

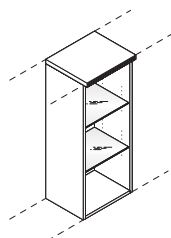

STYLE NUMBER	LIST PRICE	SPECIFICATIONS
<i>14-1/2"W - 17- 1/2"W x 14"D Shelf</i>		
GS14H	65 ea	- Glass Shelves Replace Wood Shelf In Open Or Glass Door Cabinet. Also Order Interior Cabinet Lighting.

**Notes**  
- Replace only adjustable shelves between cabinet light and fixed lower wood shelf.

Available: - All DARRAN Collections

SHELF MODIFICATIONS

CURVED CORNER GLASS SHELF

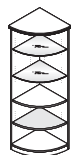

STYLE NUMBER	LIST PRICE	SPECIFICATIONS
GS14CC	85 ea	- Curved shelves feature glass retainer clips to prevent tipping

**Notes**  
- Replace only adjustable shelves between cabinet light and fixed lower wood shelf.

Available: - All DARRAN Collections. Excludes Rail.

**SHELF MODIFICATIONS**

**HEAVY DUTY SOLID WOOD BOOKCASE REPLACEMENT SHELVES**

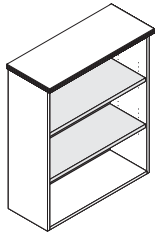

**STYLE NUMBER**  
**1" Wood Shelf 14" Deep**  
 S714F  
**1" Wood Shelf 24" Deep**  
 S714FX

**LIST PRICE**  
 75 ea  
 150 each

**SPECIFICATIONS**  
 - 1" Solid Lumber Core Shelves Replace Standard 3/4" Plywood  
 Adjustable And Fixed Shelves

Available: - All DARRAN Collections. Excludes Rail.

**SLAT WALL ACCESSORIES**

**SLAT WALL ACCESSORY TRAY**

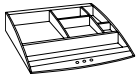

**STYLE NUMBER**  
 SWA9

**LIST PRICE**  
 45

**SPECIFICATIONS**  
 - Specify Black Or Matte Silver

Available: - All DARRAN Collections. Excludes Rail.

**SLAT WALL ACCESSORIES**

**SLAT WALL FOLDER TRAY**



**STYLE NUMBER**  
 SWA7

**LIST PRICE**  
 45

**SPECIFICATIONS**  
 - Specify Black Or Matte Silver

Available: - All DARRAN Collections. Excludes Rail.

**SLAT WALL ACCESSORIES**

**SLAT WALL PAPER TRAY**

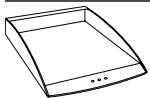

**STYLE NUMBER**  
 SWA2

**LIST PRICE**  
 35

**SPECIFICATIONS**  
 - Specify Black Or Matte Silver

Available: - All DARRAN Collections. Excludes Rail.

SLAT WALL ACCESSORIES

SLAT WALL PENCIL HOLDER



**STYLE NUMBER**  
SWA4

**LIST PRICE**  
25

**SPECIFICATIONS**  
- Specify Black Or Matte Silver

Available: - All DARRAN Collections. Excludes Rail.

SPECIALTY VENEER ACCENTS

BLACK EBONY WOOD INLAY IN ONE PIECE CONFERENCE TOP

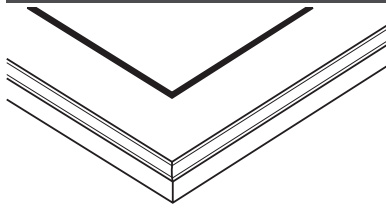

**STYLE NUMBER**  
*One Piece Conference Top*  
T30  
*Two Piece Conference Top*  
T31

**LIST PRICE**  
735  
  
1480

**SPECIFICATIONS**  
- Standard veneer top is routed for Ebony wood inlay 1/8" x 3/16" width line. Inlay wood is miter jointed in the corners, hand fitted, glued and sanded flush with top veneer. Inlay forms a 3" border to top edge

**Notes**  
- Hand fitted miter corner Black Ebony wood inlay installed in standard wood veneer tops

Available: - Conferencing Tops.

SPECIALTY VENEER ACCENTS

BLACK/WHITE/BLACK WOOD INLAY

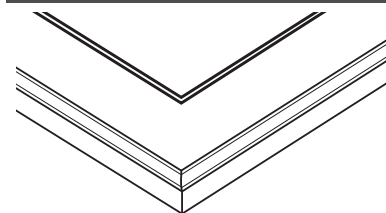

**STYLE NUMBER**  
*One Piece Top*  
T30BWB  
*Two Piece Top*  
T31BWB

**LIST PRICE**  
950  
  
1795

**SPECIFICATIONS**  
- Standard veneer top is routed for wood inlay 1/8" x 3/16" width line. Each color is 1/16" wide. White inlay line is finished over providing a subtle contrast to line detail

**Notes**  
- Hand fitted miter corner ebony-maple-ebony wood inlay installed in standard veneer top  
- The center white line can be masked off preventing color stains from penetrating. Final top coats are applied over the white line.

Available: - Conferencing Tops

SPECIALTY VENEER ACCENTS

BLACK EBONY WOOD INLAY W/ WOOD FAN DETAIL - 1 PIECE CONFERENCE TABLE TOP

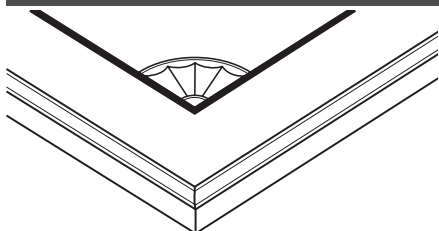

**STYLE NUMBER**  
*One Piece Top*  
T51  
*Two Piece Top*  
T52

**LIST PRICE**  
1160  
  
2110

**SPECIFICATIONS**  
- Standard veneer top is routed for wood inlay 1/8" x 3/16" width line. With each 90 degree corner routed for Quarter circle fan inlays. Inlay fans combined with solid black inlay preserves an old traditional appearance. Fans are handcrafted from teakwood, rosewood, mahogany, and other exotic woods. Each piece of veneer is shaded by burning and is hand fitted to a perfect fan shape - truly and old world craft  
- Conference tables: 4 fans, one in each corner per top section

**Notes**  
- Hand fitted miter corner wood inlay and fan installed in standard veneer top  
- Only available on square/ rectangle tops

Available: - Conferencing Tops

**SPECIALTY VENEER ACCENTS**

**CROTCH MAHOGANY INFIELD WITH MITERED BORDER**



**STYLE NUMBER**

- TCB-1 - 84 x 36/42
- TCB-2 - 72 x 36/42
- TCB-3 - 72 x 30/36

**LIST PRICE**

- 1895
- 1795
- 1695

**SPECIFICATIONS**

- Center balanced butt and book matched crotch mahogany
- 35 sheen non-rubbed finish ensures maximum durability

Available: - Jamestown, Prado

**SPECIALTY VENEER ACCENTS**

**CROTCH MAHOGANY DESK PEDESTAL FRONTS**

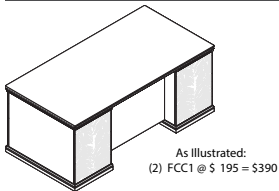

Desk Approach  
Pedestal Fronts

**STYLE NUMBER**

FCC1

**LIST PRICE**

195 per pedestal

**SPECIFICATIONS**

- Center balanced butt and book matched crotch mahogany
- 35 sheen non-rubbed finish ensures maximum durability

Available: - Jamestown, Prado

**SPECIALTY VENEER ACCENTS**

**CROTCH MAHOGANY DRAWER FRONTS**

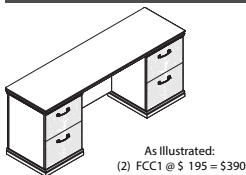

Box/Box/File or File/File  
Drawer Fronts

**STYLE NUMBER**

FCC1

**LIST PRICE**

195 per pedestal

**SPECIFICATIONS**

- Center balanced butt and book matched crotch mahogany
- 35 sheen non-rubbed finish ensures maximum durability

Available: - Jamestown, Prado

**SPECIALTY VENEER ACCENTS**

**CROTCH MAHOGANY DOUBLE WIDTH PANEL FRONTS**



All Three Illustrations Represent: (1) FCC2 @ \$395

30-32-36 Width  
FCC-2 \$395 per Panel Set

**STYLE NUMBER**

FCC2

**LIST PRICE**

395 per Panel Set

**SPECIFICATIONS**

- Center balanced butt and book matched crotch mahogany
- 35 sheen non-rubbed finish ensures maximum durability

Available: - Jamestown, Prado

**SPECIALTY VENEER ACCENTS**

**CROTCH MAHOGANY DOUBLE WIDTH/ DOUBLE HEIGHT FRONTS**



**STYLE NUMBER**  
FCC3

**LIST PRICE** 895 per Panel Set  
**SPECIFICATIONS**  
 - Center balanced butt and book matched crotch mahogany  
 - 35 sheen non-rubbed finish ensures maximum durability

Both Illustrations Represent:  
 (1) FCC3 @ \$895 - Panel Set  
 30-36 Width  
 FCC-3 \$895 per Panel Set  
 52" Center Balance Butt & Bookmatch

Available: - Jamestown, Prado

**SPECIALTY VENEER ACCENTS**

**RECTANGLE INLAY - RECESSES DURA-LEATHER WRITING SURFACE**

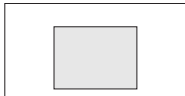

RECTANGLE INLAY

**STYLE NUMBER**  
RL-29A

**LIST PRICE** 895  
**SPECIFICATIONS**  
 - Recessed inlay desk pads are covered with Alomost Leather from Paul Brayton Designs.  
 - DARRAN will gladly custom quote other inlay materials ie: solid surfaces, biocomposites, metallic laminates, or genuine leather to match seating

Available: - All DARRAN Collections

**SPECIALTY VENEER ACCENTS**

**BOWFRONT INLAY - RECESSES DURA-LEATHER WRITING SURFACE**

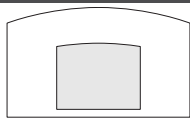

BOWFRONT INLAY

**STYLE NUMBER**  
RL-31A

**LIST PRICE** 995  
**SPECIFICATIONS**  
 - Recessed inlay desk pads are covered with Alomost Leather from Paul Brayton Designs.  
 - DARRAN will gladly custom quote other inlay materials ie: solid surfaces, biocomposites, metallic laminates, or genuine leather to match seating

Available: - All DARRAN Collections

**SPECIALTY VENEER ACCENTS**

**RECTANGLE INLAY - EBONY HARDWOOD INLAY DETAIL**

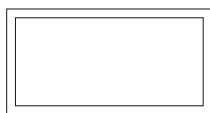

RECTANGLE INLAY

**STYLE NUMBER**  
T10SA

**LIST PRICE** 895  
**SPECIFICATIONS**  
 - 3/16" x 3/16" thick hardwood ebony inlay is handfitted and glued into routed top and sanded flush with surface  
 - Inlay is finished over with all finish steps

**Notes**  
 - Ebony inlay not recommended in: Koko Cherry

Available: - All DARRAN Collections

**SPECIALTY VENEER ACCENTS**

**BOWFRONT INLAY - EBONY HARDWOOD INLAY DETAIL**

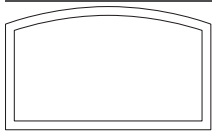

CURVED INLAY

**STYLE NUMBER**

T11SA

**LIST PRICE**

995

**SPECIFICATIONS**

- 3/16" x 3/16" thick hardwood ebony inlay is handfitted and glued into routed top and sanded flush with surface
- Inlay is finished over with all finish steps

**Notes**

- Ebony inlay not recommended in: Koko Cherry

Available: - All DARRAN Collections

**TOOL CHANNEL ACCESSORIES**

**RECESSED ALUMINUM TOOL CHANNEL**

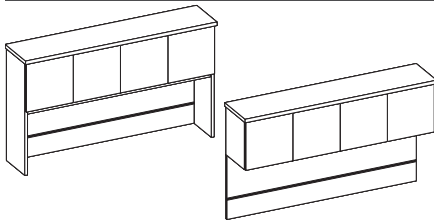

**STYLE NUMBER**

ATB02

**LIST PRICE**

5 per 1"W

**SPECIFICATIONS**

- Anodized aluminum finish
- Fully recessed
- Finish matches anodized aluminum accessories
- Can be specified with fabric tack surface mounted above channel

**Notes**

- If using tool channel with wallhung overhead, a veneer panel must be specified.

Available: - All DARRAN Collections. Excludes Rail.

**TOOL CHANNEL ACCESSORIES**

**FILE HOLDER**

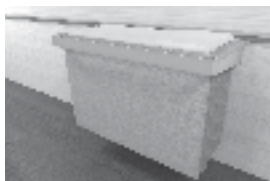

**STYLE NUMBER**

ATB37

**LIST PRICE**

105

**SPECIFICATIONS**

- For Console/Wall Hung Back Panels With Optional Tool Bar
- 18 Gauge Steel - Stamp Formed
- Silver Powderdercoat Finish

Available: - All DARRAN Collections. Excludes Rail.

**TOOL CHANNEL ACCESSORIES**

**IPHONE HOLDER**



**STYLE NUMBER**

ATB31

**LIST PRICE**

120

**SPECIFICATIONS**

- For Console/Wall Hung Back Panels With Optional Tool Bar
- 18 Gauge Steel - Stamp Formed
- Silver Powderdercoat Finish
- 5" x 3 -3/4"W
- Non-slip Neoprene pad

Available: - All DARRAN Collections. Excludes Rail.

**TOOL CHANNEL ACCESSORIES**

**LARGE SHELF**

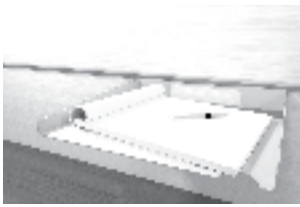

**STYLE NUMBER**  
ATB35

**LIST PRICE**  
125

**SPECIFICATIONS**  
- 12"W x 10"D

Available: - All DARRAN Collections. Excludes Rail.

**TOOL CHANNEL ACCESSORIES**

**PENCIL PEN HOLDER**



**STYLE NUMBER**  
ATB38

**LIST PRICE**  
115

**SPECIFICATIONS**  
- For Console/Wall Hung Back Panels With Optional Tool Bar  
- 18 Gauge Steel - Stamp Formed  
- Silver Powderdercoat Finish  
- 5"H x 4"W x 4"D

Available: - All DARRAN Collections. Excludes Rail.

**TOOL CHANNEL ACCESSORIES**

**SMALL SHELF**



**STYLE NUMBER**  
ATB36

**LIST PRICE**  
110

**SPECIFICATIONS**  
- 12"W x 6 -3/4"D

Available: - All DARRAN Collections. Excludes Rail.

**TOOL CHANNEL ACCESSORIES**

**TABLET HOLDER**

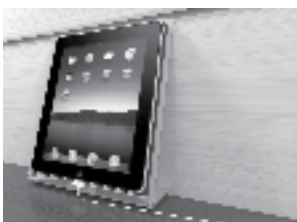

**STYLE NUMBER**  
ATB30

**LIST PRICE**  
135

**SPECIFICATIONS**  
- For Console/Wall Hung Back Panels With Optional Tool Bar  
- 18 Gauge Steel - Stamp Formed  
- Silver Powderdercoat Finish  
- 10" x 8"W  
- Non-slip Neoprene pad

Available: - All DARRAN Collections. Excludes Rail.



TOP MODIFICATION

1/4" RECTANGLE SOFT ETCH GLASS RUNOFF WORKSURFACE

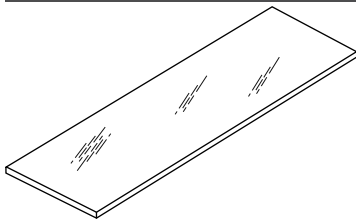

STYLE NUMBER

SEGW8436  
 SEGW8430  
 SEGW7836  
 SEGW7830  
 SEGW7230  
 SEGW6630  
 SEGW6030

LIST PRICE

2210  
 1870  
 2070  
 1750  
 1630  
 1515  
 1395

SPECIFICATIONS

- 1/4" Soft etch glass  
 - Back painted white glass

Notes

- Additional colors can be custom quoted. Contact factory for pricing.

Available: - Rift Runoff Worksurface

TOP MODIFICATION

TOP APRON RAIL

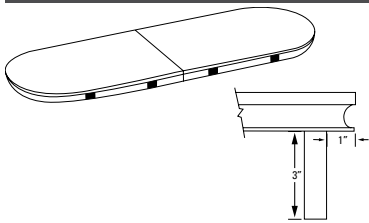

STYLE NUMBER

TAR

LIST PRICE

Add 10% to top price for apron only

SPECIFICATIONS

- 3 x 3/4 thick apron rail is set back under top 1".  
 - Apron rail is recommended for fixed port installation for power/data support.

Notes

- Select power/data support separately.  
 - See power options for available apron power: UDT2/VD-SM

Available: - Conferencing Tops Only

TOP MODIFICATION

TOP APRON RAIL

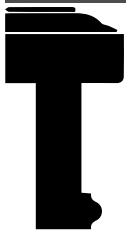

STYLE NUMBER

TAR-M

LIST PRICE

Add 15% (Apron rail with beltline detail)

SPECIFICATIONS

- Traditional with apron rail and molding - available in Cherry and Walnut.

Notes

- Select power/data support separately.  
 - See power options for available apron power: UDT2/VD-SM

Available: - Conference tops only

WIRE MANAGEMENT

HORIZONTAL J-CHANNEL WIRE MANAGEMENT RACEWAY

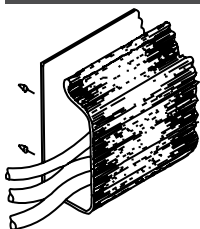

STYLE NUMBER

W1

LIST PRICE

75 Per 4 Foot Section

SPECIFICATIONS

- 4' section for field installation.  
 - The "J" shape black thermoplastic wire raceway may be added to specified worksurface tops to provide concealed channeling of wires to and from worksurface grommets. For use in open kneespace areas, raceway is attachable to top of back panel with pan head screws. Interior dimensions are 1" x 1- 1/2" providing ample storage for multiple wires and excess cable. Front of raceway flexes out for easy cord insertion.

Notes

- Units w/ Wire Channel Standard.  
 - Field Installation

Available: - All DARRAN Collections.

WIRE MANAGEMENT

HORIZONTAL U-CHANNEL WIRE MANAGEMENT RACEWAY



**STYLE NUMBER**  
W2A

**LIST PRICE**  
75 Per 4 Foot Section

**SPECIFICATIONS**  
- 4' section for field installation.

**Notes**  
- Units w/ Wire Channel Standard.  
- Field Installation

Available: - All DARRAN Collections.

WIRE MANAGEMENT

COIL WIRE MANAGER



**STYLE NUMBER**  
W18

**LIST PRICE**  
150

**SPECIFICATIONS**  
- Weighted Base, Table attachment plate  
- 39- 1/2" Length  
- Black

**Notes**  
- Location

Available: - All DARRAN Collections.

WIRE MANAGEMENT

STANDARD LOCATION GROMMETS - FACTORY INSTALLED

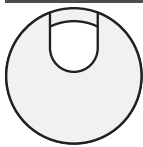

**STYLE NUMBER**  
*Standard Location Grommet*

**Black**  
TM30

**Silver**  
TM31

**Antique Brass**  
TM33

**White**  
TM34

**LIST PRICE**

45

45

45

45

45

**SPECIFICATIONS**  
- 1 -5/8" Metal Grommet

**Notes**  
- \*Units w/ Grommets Standard Are Noted Under Standard Features. Grommets Match Pull Finish - Standard (Unless Specified Otherwise)

Available: - All DARRAN Collections.

WIRE MANAGEMENT

NON-STANDARD LOCATION GROMMETS - FACTORY INSTALLED

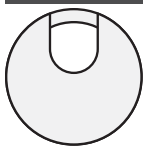

**STYLE NUMBER**  
*Non-Standard Location Grommet*

**Black**  
TM30 -NS

**Silver**  
TM31 -NS

**Antique Brass**  
TM33 -NS

**White**  
TM34 -NS

**LIST PRICE**

90

90

90

90

90

**SPECIFICATIONS**  
- 1 -5/8" Metal Grommet

**Notes**  
- \*Units w/ Grommets Standard Are Noted Under Standard Features. Grommets Match Pull Finish - Standard (Unless Specified Otherwise)

Available: - All DARRAN Collections

**WIRE MANAGEMENT**

**BLACK PLASTIC VERTICAL SURFACE GROMMETS - FACTORY INSTALLED**



STYLE NUMBER	LIST PRICE	SPECIFICATIONS
<i>Standard Location Grommet</i>		- 2 " Black Plastic Grommet
TM50-C	45	<b>Notes</b> - Standard Location is Bottom Center
<i>Non-Standard Location Grommet</i>		
TM50-NS	90	

Available: - All DARRAN Collections

**WORKSTATION**

**CLIENT PULLOUT WRITING SHELF**

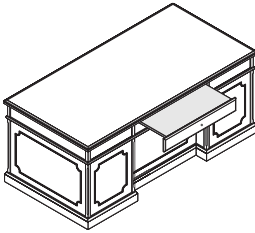

STYLE NUMBER	LIST PRICE	SPECIFICATIONS
CP-1	425	- CP-1: Client pull-out writing shelf for executive chassis desk
CP-2	625	- CP-2: Client pull-out writing shelf for conference desk

Available: - Jamestown

**AIRCHARGE WIRELESS CHARGING GROMMET**

STYLE NUMBER	LIST PRICE
ACWG WIRELESS GROMMET	\$575
ACWR WIRELESS RECEIVER W/ LIGHTNING CABLE	\$170



AirCharge Wireless Grommet

**SPECIFICATIONS**

- AirCharge offers a convenient way to charge any Qi compatible smartphone or device without the need to carry charging cables or find an available power outlet. Devices not equipped with the Qi technology, can be adapted to accept a charge from the grommet with the AirCharge Wireless Receiver.
- Size: 3.33" DIA x .75"D
- Compatible with an Qi rated device, Contact Customer Service for compatibility list
- Non-Qi device can be adapted to accept AirCharge unit with an ACWR AirCharge Wireless Receiver (compatible with iPhone)
- Surface Mount
- 78" Cord
- Standard Black Aluminum Finish; Available in White Aluminum or Black Finish upon request

**AVAILABLE**

- All Darran Collections



iphone w/ ACWR



Black Aluminum



Black Finish



White Aluminum

## COVE POWER UNIT - NON-LINKING

STYLE NUMBER	LIST PRICE
 PD COVE PLUG Non-Linking Version	\$550

**SPECIFICATIONS**

- Size 5.75" L x 2.5" W
- (2) 15 Amp Receptacles and (2) USB charging ports
- Surface Mount
- 108" Cord
- Standard Silver Finish, Available in White or Black Finish upon request
- ETL Listed

**AVAILABLE**

- All Darran Collections



## COVE POWER UNIT WITH DAISYLINK

### STYLE NUMBER

### LIST PRICE

#### STARTER UNITS



#### COV-DCH HARDWIRED

\$710

Includes (1) Cove unit with Hardwire Infeed - 120"



#### COV-DCP PLUG

\$800

Includes (1) Cove unit with Plug infeed - Includes 72" Cord and 32" Infeed Jumper for 104" total cord infeed

#### ADDITIONAL LINKING UNITS

#### COV-DCL

\$575 EACH

Includes Linking Cove unit and Jumper up to 96", cable length determined by the top size

### SPECIFICATIONS

- Size: 5.75" L x 2.5" W
- (2) 15 Amp Receptacles and (2) 2.1 Amp USB charging ports
- Surface Mount
- Max Daisy Chain - Hardwire - (9) units; Plug/Corded - (4) units
- Standard Silver Finish, Available in White or Black Finish upon request
- ETL Listed

### AVAILABLE

- All Darran Collections



## COVE CORDED SERIES

STYLE NUMBER	LIST PRICE
 PD-COVE-PKO	\$800

**SPECIFICATIONS**

- Size 9.5" L x 2.5" W x 3.18" D
- (2) Power Receptacles, (2) 2.1 Amp USB charging ports and (1) Telecom Plate Knockout
- Surface Mount
- 108" Cord
- Standard Silver Finish, Available in White or Black Finish upon request
- ETL Listed

**AVAILABLE**



- All Darran Collections

**TELECOM PLATES**

*THIS POD CAN HAVE UP TO 1 TOTAL PLATES*

STYLE NUMBER	LIST PRICE
RJ45 (1)	\$35
RJ45 (2)	\$70
RJ45 (3)	\$105
USB (1)	\$70
USB (2)	\$140
RJ11/RJ45	\$70
RJ45/USB	\$105
RJ45/HDMI	\$190
HDMI/DVI	\$325
HDMI/USB	\$205
HDMI/VGA	\$240
VGA/MINI-STEREO	\$155
VGA/USB	\$175

**PDFAA FLUSH DATA BAY ANODIZED ALUMINUM DOOR**

STYLE NUMBER	LIST PRICE
 PDFAA-H Hardwired	\$1195
 PDFAA-C Plug	\$1195
 PDFAA-DC Daisy Chain	\$1395

Features convenience plug on bottom - Max Daisy chain (4) units  
 - Specify hardwired or plug for the first unit in series, daisy chained units will have a plug for connection through convenience plug.



**SPECIFICATIONS**

- Size 13.75”L x 6.375”W x 2.85”D
- (4) 15 Amp receptacles
- Surface Mount
- Standard Interior Black Finish
- Specify up to (4) Telecom Plates; (2) on side and (2) on bottom
- Corded units are UL Listed and CSA Certified. Hardwired Units are CSA Certified

**AVAILABLE**

- All Darran Collections
- Excludes Rail, Grove



**TELECOM PLATES**

*THIS POD CAN HAVE UP TO 4 TOTAL PLATES*

STYLE NUMBER	LIST PRICE
RJ45 (1)	\$35
RJ45 (2)	\$70
RJ45 (3)	\$105
USB (1)	\$70
USB (2)	\$140
RJ11/RJ45	\$70
RJ45/USB	\$105
RJ45/HDMI	\$190
HDMI/DVI	\$325
HDMI/USB	\$205
HDMI/VGA	\$240
VGA/MINI-STEREO	\$155
VGA/USB	\$175



**PDFAF FLUSH DATA BAY FROSTED GLASS DOOR WITH DAISYLINK**

STYLE NUMBER	LIST PRICE
 PDFAF-H HARDWIRED	\$1095
 PDFAF-C PLUG	\$1095
 PDFAF-DC DAISY CHAIN	\$1295

Features convenience plug on bottom - Max Daisy chain (4) units  
 - Specify hardwired or plug for the first unit in series, daisy chained units will have a plug for connection through convenience plug.



**SPECIFICATIONS**

- Size 13.75”L x 6.375”W x 2.85”D
- (4) 15 Amp receptacles
- Surface Mount
- Standard Interior Black Finish
- Specify up to (4) Telecom Plates; (2) on side and (2) on bottom
- Corded units are UL Listed and CSA Certified. Hardwired Units are CSA Certified

**AVAILABLE**

- All Darran Collections
- Excludes Rail, Grove



**TELECOM PLATES**

*THIS POD CAN HAVE UP TO 4 TOTAL PLATES*

STYLE NUMBER	LIST PRICE
RJ45 (1)	\$35
RJ45 (2)	\$70
RJ45 (3)	\$105
USB (1)	\$70
USB (2)	\$140
RJ11/RJ45	\$70
RJ45/USB	\$105
RJ45/HDMI	\$190
HDMI/DVI	\$325
HDMI/USB	\$205
HDMI/VGA	\$240
VGA/MINI-STEREO	\$155
VGA/USB	\$175

**REEF POWER UNIT WITH DAISYLINK**

**STYLE NUMBER**

**LIST PRICE**



REF310 PLUG

\$1100

**SPECIFICATIONS**

- Size 16.1”L x 6.25”W x 4.89”D
- (3) 120V Receptacles, (2) USB charging ports and (2) Knockouts for RJ45 Data Ports
- Surface Mount
- 108” Cord
- Features Convenience Plug on bottom of unit that allows for max (3) Daisy Chain
- Standard Black Finish, Available in White or Silver Finish upon request
- Additional Telecom Plate Knockout
- When used with Grove Tables an additional \$350 LIST will apply for the special cutout required.
- RJ45 for Knockouts not required. If not ordered a small hole will be present in this this location
- ETL Listed

**AVAILABLE**

- Grove
- Conferencing



**TELECOM PLATES**

*THIS POD CAN HAVE UP TO 1 TOTAL PLATES*

STYLE NUMBER	LIST PRICE
RJ45 (1)	\$35
RJ45 (2)	\$70
RJ45 (3)	\$105
USB (1)	\$70
USB (2)	\$140
RJ11/RJ45	\$70
RJ45/USB	\$105
RJ45/HDMI	\$190
HDMI/DVI	\$325
HDMI/USB	\$205
HDMI/VGA	\$240
VGA/MINI-STEREO	\$155
VGA/USB	\$175



## SECLUSION CORDED POWER UNIT NON-LINKING

## STYLE NUMBER

## LIST PRICE



P2SECL

\$245

Choose from plate mount or clamp mount (seen in photo)

## SPECIFICATIONS

- Size: 3.5"L x 2.2"D x 2.5"H
- (2) Power Receptacles
- Worksurface Clamp Mount or Plate Under Surface Mount
- Clamp Accessory accommodates table thickness up to 2"
- 72" Cord
- Standard Silver Finish, Black Finish available upon request
- UL/UCL Listed

## AVAILABLE

- All Darran Collections



Clamp Mount

**UDT POWER UNIT - NON-LINKING**

STYLE NUMBER	LIST PRICE
 <b>UDT2/VD-SM PLUG</b> Non-Linking	\$350



**SPECIFICATIONS**

- Size 6.5"L x 2.81"D x 1.26"H
- (2) Power receptacles and (1) Telecom Plate Cutout
- Side Mount, if Top Mount is required contact customer service
- 72" Cord
- Standard Black Powdercoat Finish
- Used in Apron Rails
- UL Listed

**AVAILABLE**

- Conferencing Apron Rails

**TELECOM PLATES**

*THIS POD CAN HAVE UP TO 1 TOTAL PLATES*

STYLE NUMBER	LIST PRICE
RJ45 (1)	\$35
RJ45 (2)	\$70
RJ45 (3)	\$105
USB (1)	\$70
USB (2)	\$140
RJ11/RJ45	\$70
RJ45/USB	\$105
RJ45/HDMI	\$190
HDMI/DVI	\$325
HDMI/USB	\$205
HDMI/VGA	\$240
VGA/MINI-STEREO	\$155
VGA/USB	\$175

## VILLA POWER UNIT - NON-LINKING

STYLE NUMBER	LIST PRICE
 VIL-C PLUG Non-Linking	\$515

## SPECIFICATIONS

- Size: Top Grommet 5.68"L X 3.39"W; Under Top 12"L x 3.13"W x 3.08"D
- (2) Power receptacles; (2) USB charging ports and (1) Knockouts for RJ45 Data Ports
- Surface Mount
- 72" Cord (Longer cord available, contact Customer Service)
- Standard Silver Finish, Black Finish available upon request
- UL or ETL Certified

## AVAILABLE

- All Darran Collections
- Excludes Grove

## RJ45 KNOCKOUT

STYLE NUMBER	LIST PRICE
RJ45 (1)	\$35



**VILLA POWER UNIT WITH DAISYLINK**

**STYLE NUMBER LIST PRICE**

**STARTER UNITS**



**VIL-DCH HARDWIRED** \$600  
Includes (1) Villa unit with 120" Hardwire Infeed



**VIL-DCP PLUG** \$695  
Includes (1) Villa with Plug Infeed - Includes 72" Cord and 32" Infeed Jumper for 104" total cord infeed

**ADDITIONAL LINKING UNITS**

**VIL-DCL ADDITIONAL** \$590  
(Includes linking Villa and Jumper cable up to 96")

**SPECIFICATIONS**

- Size: Top Grommet 5.68" L X 3.39"W; Under Top 12"L x 3.13"W x 3.08"D
- (4) Power receptacles; (2) surface and (2) undersurface, (2) 2.1A USB charging ports and (1) Knockout for RJ45 Data Port
- Surface Mount
- Daisy Chain - Hardwire Max (10) Units, Plug/Corded Max (5) Units
- Standard Silver Finish, Black Finish available upon request
- UL or ETL Certified

**AVAILABLE**

- All Darran Collections
- Excludes Grove



**RJ45 KNOCKOUT**

**STYLE NUMBER LIST PRICE**

RJ45 (1) \$35